

Thermo Scientific NESLAB Merlin Recirculating Chiller

Thermo Scientific Manual P/N U00753
Rev. 09/20/10

Installation Operation Basic Service



Visit our Web site at:

<http://www.thermoscientific.com/tc>
Product Service Information, Applications
Notes, MSDS Forms, e-mail.

Voice Info: (800) 258-0830

Thermo Fisher Scientific

25 Nimble Hill Road
Newington, NH 03801
Tel : (800) 258-0830 or
(603) 436-9444
Fax : (603) 436-8411
www.thermoscientific.com/tc

Sales, Service, and Customer Support

25 Nimble Hill Road
Newington, NH 03801
Tel: (800) 258-0830
Sales: 8:00 am to 5:00 pm
Service and Support: 8:00 am to 6:00 pm Monday
through Friday (Eastern Time)
Fax: (603) 436-8411
service.tc.us@thermofisher.com

Dieselstrasse 4
D-76227 Karlsruhe, Germany
Tel : +49 (0) 721 4094 444
Fax : +49 (0) 721 4094 300
info.tc.de@thermofisher.com

Building 6, No. 27
Xin Jinqiao Rd., Shanghai 201206
Tel : +86(21) 68654588
Fax : +86(21) 64457830
info.china@thermofisher.com

Statement of Copyright

Copyright © 2010 Thermo Fisher Scientific. All rights reserved.

This manual is copyrighted by Thermo Fisher Scientific.

Users are forbidden to reproduce, republish, redistribute, or resell any materials from this manual in either machine-readable form or any other form.

Contents

Preface	iii
Compliance	iii
WEEE/RoHS	iii
After-sale support	iv
Feedback	iv
Warranty	iv
Unpacking.....	v
Safety Warnings	vi
Quick Reference Operating Procedures	ix
Chapter 1 Description	1
Specifications	2
Chapter 2 Installation and Operation	7
Site	7
Electrical Requirements	8
Plumbing Requirements	10
Fluids	11
Filling Requirements	12
Reservoir Tank Isolation Valves/Open Tank Circulation	12
Controller	13
Start Up/Shut Down	15
Setup/Tuning Loop	18
Chapter 3 Options	21
Communication Connector	21
Remote Start/Stop	22
External Temperature Sensor	23
Reservoir Level Warning/Fault	24
Low Pump Flow Warning/Fault	24
Additional Accessories	24
Chapter 4 Maintenance	25
Error Codes	25
Displaying Software Version Number	26
Controller PID Values	27
Cleaning	27
Algae	28
Leaks.....	28
Phase Rotation Interlock	28

	PD Pressure Relief Valve	29
	Pump Strainer	30
	PD Pump Motor Lubrication	31
	Storage	32
	BOM Decoder	32
	Temperature Sensor Calibration	32
Chapter 5	Troubleshooting	
	Checklist	37
	Service Assistance	39
Appendix A	Water Quality Standards and Recommendations	41
Appendix B	NC Serial Communications Protocol	47
	Warranty	

Preface

Compliance

Listed to:
UL 61010-1 2nd Edition

Products tested and found to be in compliance with the requirements defined in the EMC standards defined by 89/336/EEC as well as Low Voltage Directive (LVD) 73/23/EEC can be identified by the CE Mark on the rear of the unit. The testing has demonstrated compliance with the following directives:

- LVD, 73/23/EEC IEC/EN 61010-1
- EMC, 89/336/EEC IEC/EN 61326-1

For any additional information, refer to the Declaration of Conformity that shipped with the unit.

WEEE/RoHS

This product is required to comply with the European Union's Waste Electrical & Electronic Equipment (WEEE) Directive 2002/96/EC. It is marked with the following symbol:



Thermo Fisher Scientific has contracted with one or more recycling/disposal companies in each EU Member State, and this product should be disposed of or recycled through them. Further information on Thermo Fisher Scientific's compliance with these Directives, the recyclers in your country, and information on Thermo Scientific products which may assist the detection of substances subject to the RoHS Directive are available at:

www.thermo.com/WEEERoHS

After-sale Support

Thermo Fisher Scientific is committed to service both during and after the sale. If you have questions concerning operation, contact our Sales Department. If your unit fails to operate properly, or if you have questions concerning spare parts or Service Contracts, contact our Service Department.

Before calling, please obtain the following information:

- unit BOM number (see page 32)
- unit serial number
- unit software version (see page 26)
- voltage of power source

The unit's BOM and serial number are located on the name plate label on the rear of the unit.

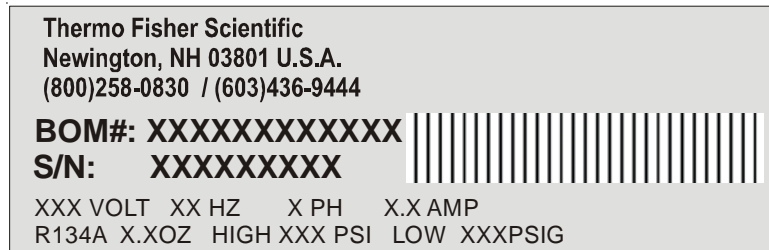

Feedback

We appreciate any feedback you can give us on this manual. Please e-mail us at thermoscientificmanuals@thermofisher.com. Be sure to include the manual part number and the revision date listed on the front cover.

Warranty

Thermo Scientific NESLAB Merlin units have a warranty against defective parts and workmanship for 24 months from date of shipment. See back page for more details.

Unpacking

Retain all cartons and packing material until the unit is operated and found to be in good condition. If the unit shows external or internal damage contact the transportation company and file a damage claim. Under ICC regulations, this is your responsibility.

Out of Box Failure

An Out of Box Failure is defined as any product that fails to operate in conformance with sellers published specifications at initial power up. The unit must be installed in accordance with manufacturer's recommended operating conditions within 30 days of shipment from the seller.

Any Temperature Control product meeting the definition of an Out of Box Failure must be packed and shipped back in the original packaging to Thermo Fisher Scientific for replacement with a new unit; Seller to pay the cost of shipping. Customer must receive a Return Material Authorization (RMA) from Thermo Fisher prior to shipping the unit.

Safety Warnings



Warnings are posted throughout the manual. These warnings are designated by an exclamation mark inside an equilateral triangle and text highlighted in bold. Read and follow these important instructions. Failure to observe these instructions can result in permanent damage to the unit, significant property damage, or personal injury or death.



The lightning flash with arrow symbol, within an equilateral triangle, is intended to alert the user to the presence of non-insulated "dangerous voltage" within the unit's enclosure. The voltage may be of significant enough magnitude to constitute a risk of electrical shock.

Make sure you read and understand all instructions and safety precautions listed in this manual before installing or operating your unit. If you have any questions concerning the operation of your unit or the information in this manual, please contact our Sales Department (see After-sale Support).

Never place the unit in a location where excessive heat, moisture, or corrosive materials are present. ▲

The unit construction provides protection against the risk of electrical shock by grounding appropriate metal parts. The protection may not function unless the power cord is connected to a properly grounded outlet. It is the user's responsibility to assure a proper ground connection is provided. ▲

Never connect the process fluid inlet or outlet fittings to your building water supply or any water pressure source. ▲

Never use flammable or corrosive fluids with this unit. Highly distilled and deionized water may be aggressive and cause material corrosion. Please contact Thermo Fisher before subjecting this unit to prolonged exposure to highly distilled or deionized water. ▲

Do not use automotive antifreeze. Commercial antifreeze contains silicates that can damage the pump seals. Use of automotive antifreeze will void the manufacturer's warranty. ▲

In addition to the specific warnings listed on the previous page the following general warnings also apply to your unit:

Performance of installation, operation, or maintenance procedures other than those described in this manual may result in a hazardous situation and may void the manufacturer's warranty. ▲

Transport the unit with care. Sudden jolts or drops can damage the unit's components. ▲

If the unit is to be transported and/or stored it needs to be drained. If the unit is to be transported and/or stored in cold temperatures it needs to be drained and then flushed with a 50/50 glycol/water mixture. ▲

The circuit protector located on the rear of the unit is not intended to be used as a disconnecting means. ▲

Observe all warning labels. ▲

Never remove warning labels. ▲

Never operate damaged or leaking equipment. ▲

Never operate the unit without cooling fluid in the reservoir. ▲

Always turn off the unit and disconnect the power cord from the power source before performing any service or maintenance procedures, or before moving the unit. ▲

Never operate equipment with damaged power cords. ▲

Refer service and repairs to a qualified technician. ▲

Indicates **refrigeration system status**. See page 13.

Optional. Flashes to indicate the **external sensor** is enabled. See page 23.

Indicates the controller is displaying the **setpoint**. Press the arrow keys to change the value. See pages 13 - 14.

Indicates the controller is displaying the unit's **low temperature alarm setting**. Press the arrow keys to change the value. See pages 13 - 14.

Press to **sequence** through the four indicators and accept the displayed value. See page 13.
NOTE: None of the four indicators are visible unless this key is pressed.

Reservoir Access Panel. See pages 10 - 12.

Controller. See page 13.

Pressure Gauge. See page 15.

Reservoir. See page 12.

Condenser Access Panel. See page 27.

Indicates the controller is displaying the **high temperature alarm setting**. Press the arrow keys to change the value. See pages 13 - 14.

Press to **mute** the alarm. See page 13.

Press to **change** the displayed value. See page 13.

Optional. Indicates the unit is operating in the **serial communication** or remote start/stop mode. See pages 13 - 14 and 16.

Press to **start/stop** the unit. See page 13.

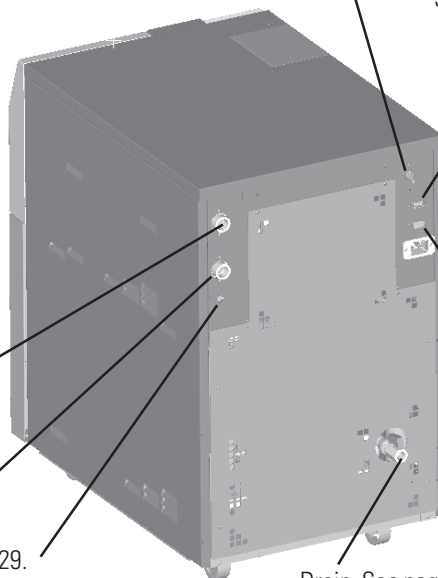
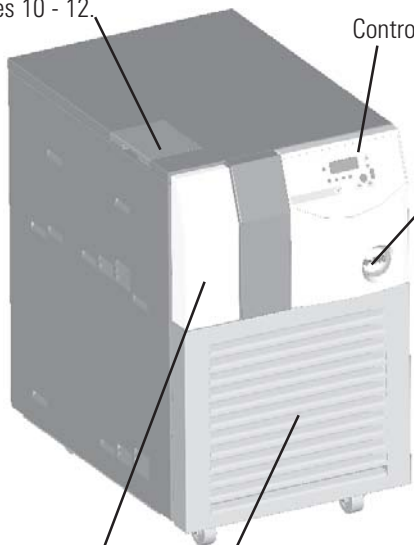



Circuit Protector. See page 15.

Optional  Communications Connector. See page 21.

 Plumbing Return Connection. See page 10.

 Plumbing Supply Connection. See page 10.

 **PSI/KPa** PD Pump Pressure Relief Valve. See page 29.

Optional  **24V** Remote Start/Stop Connector. See page 22.
 External Temperature Sensor. See page 23.

Drain. See page 10.

Quick Reference Operating Procedures





Installation

The unit has an air-cooled refrigeration system. Air is drawn in the front of the unit and discharged through rear and sides. Position the unit so the intake and discharge are not impeded. Inadequate ventilation will reduce cooling capacity and, in extreme cases, result in compressor failure.

Excessively dusty areas should be avoided and a periodic cleaning schedule should be instituted. For proper operation, the unit needs to pull substantial amounts of air through a condenser. A build up of dust or debris on the fins of the condenser will lead to a loss of cooling capacity.

The unit will retain its full rated capacity in ambient temperatures up to approximately +77°F (+25°C).

Make sure the voltage of the power source meets the specified voltage, $\pm 10\%$.



The plumbing connections are located on the rear of the unit and are labelled  and . These connections are 1/2 inch FPT (3/4 inch FPT for units with CP-55 pumps). Remove the plastic protective plugs from both plumbing connections. Connect the  fitting to the inlet of your application. Connect the  fitting to the outlet of your application.

To fill the reservoir, remove the reservoir access panel and locate the reservoir cap. Remove the cap and fill the reservoir with clean cooling fluid.

For fluid recommendations refer to page 11.



Operation

Before starting the unit, double-check all electrical and plumbing connections. Make sure the circulating system is properly filled with cooling fluid. Place the circuit breaker located on the rear of the unit to the up position.

To start the unit, press . To turn the unit off press  again.

The  LED indicates the status of the refrigeration system. It illuminates to indicate the refrigeration system is removing heat from the cooling fluid. As the operating temperature approaches the setpoint, the LED will flash.

Temperature Adjustment

To display the temperature setpoint, press  on the controller. The  indicator will illuminate and the display will flash the current setpoint value. To adjust the temperature setpoint, press the arrow keys until the desired temperature setpoint is indicated. Press  again to confirm the change. The display will rapidly flash the new value for a short time and then return to the recirculating fluid temperature.

Periodic Maintenance

Periodically inspect the reservoir fluid. If cleaning is necessary, flush the reservoir with a cleaning fluid compatible with the circulating system and the cooling fluid.

The cooling fluid should be replaced periodically. Frequency depends on the operating environment and amount of usage.

Before changing the cooling fluid ensure it is at a safe temperature.

Periodic vacuuming of the condenser fins is necessary. The frequency of cleaning depends on the operating environment. We recommend a monthly visual inspection of the condenser after initial installation. After several months, the cleaning frequency will be established.

Units with PD pumps have a strainer. If debris is in the system, the strainer will prevent the material from being drawn into the pump and damaging the pump vanes. A clogged strainer will also cause increased pump discharge pressure.

After initial installation, the strainer may become clogged. **Clean the strainer after the first week of installation.** After this first cleaning, we recommend a monthly visual inspection. After several months, the cleaning frequency will be established. Before cleaning the strainer, disconnect the power cord from the power source and drain the unit.

Kom hurtigt i gang!

Installering

Merlin-serien er luftkølet. Luftindtaget sker via ribber i kølebadets front, luftudtaget via huller bagpå og i siderne af kølebadet. Kølebadet skal anbringes således, at luftindtag og luftudtag ikke hindres. Utilstrækkelig ventilation vil forårsage nedsat kølekapacitet, og i værste fald ødelægge kompressoren.

Undgå at anbringe kølebadet i meget støvede omgivelser. Det anbefales, at indføre en periodisk og systematisk rengøringsprocedure. En kondenser sikrer kølebadets store luftindtag. Ophobning af f.eks. støv eller snavs på køleribberne medfører en nedsat kølekapacitet.

Omgivelsestemperaturen må max. være 25°C for at sikre bedst mulig drift.

Spændingen skal være 220V.

Rørtilslutningerne er anbragt på bagsiden af kølebadet og er afmærkede. Tilslutningerne er 1/2" FPT. (Kølebade med CP-55 pumpe har 3/4" FPT tilslutning). Den beskyttende plastik om begge rørtilslutninger fjernes. Tilslutningsslangen forbindes til kølebadets tilslutningsstykke. Afløbsslangen forbindes til kølebadets afløbsstykke.

Afmonter dernæst panelet til væskebeholderen. Fjern dækslet og fyld ren kølevæske i væskebeholderen.

Se side 11 i betjeningsvejledningen for anbefalet kølevæske.

Ibrugtagning

Før kølebadet tages i brug, kontrolleres alle elektriske og mekaniske tilslutninger påny. Påse ligeledes at kølevæske er fyldt på cirkulationssystemet. Afbryderknappen til cirkulationssystemet er anbragt bag på kølebadet. Afbryderen sættes i øverste position.

For at starte kølebadet, trykkes afbryderen ned. Når kølebadet skal stoppe, trykkes ned igen.

❄️ LED displayet viser kølesystemets status. Når varme fjernes fra kølevæsken, lyser displayet. Når driftstemperaturen nærmer sig setpunktet, vil LED displayet blinke.

Indstilling af temperatur

Setpunktet kan vises ved at trykke på kontrolenheden. Det indstillede setpunkt vil blinke i displayet. Ønskes setpunktet ændret, trykkes på piltasterne, indtil ønsket temperatur vises. Tryk igen for at bekræfte ændringen. Displayet vil i et kort øjeblik blinke med den valgte temperatur og vender dernæst tilbage med visning af den recirkulerende væsketemperatur.

Periodisk vedligeholdelse

Væskebeholderen kontrolleres regelmæssigt. Er rengøring nødvendig, skylles væskebeholderen med en rensesvæske, der er forenelig med cirkulationssystemet og kølevæsken.

Kølevæsken udskiftes regelmæssigt afhængig af omgivelsestemperaturen og hvor tit køleren er i brug.

Inden udskiftning af kølevæske, skal kølevæskens temperatur altid kontrolleres.

Kølerribberne bør altid holdes fri for støv og snavs. Hvor tit ribberne skal tørres af, afhænger af hvor støvede omgivelserne er. Fra fabrikkens side anbefales en månedlig inspektion af kondensoren, efter kølebadets første ibrugtagning. Dernæst bør en rengøringsprocedure indføres, således at der sikres en regelmæssig og systematisk rengøring af køleren.

Kølebade med PD-pumper har monteret et filter. Filtret forhindrer støv og snavs i at trænge ind i pumpen og ødelægge pumpefanerne. Et tilstoppet filter vil ligeledes forårsage øget tryk på afløbspumpen.

For at undgå, at filtret tilstoppes, anbefales det, at rense filtret ugen efter, køleren har været i brug første gang. Herefter bør filtret kontrolleres en gang om måneden. Inden filtret renses, skal stikket trækkes ud af stikkontakten og kølebadet tømmes for kølevæske.

Procédures De Mise En Route

1°) INSTALLATION

Il s'agit d'un groupe dont le condenseur est refroidi par air. L'air est aspiré à l'avant et rejeté sur les côtés et à l'arrière. Il faut donc que chaque côté soit suffisamment aéré. Une mauvaise ventilation affecte la capacité de refroidissement du groupe et peut entraîner des dommages au compresseur.

Un endroit très poussiéreux est donc à proscrire, et un nettoyage périodique des entrées d'air fortement recommandé.

La capacité du groupe reste maximale pour une température ambiante n'excédant pas 25°C.

S'assurer que la tension d'alimentation soit celle spécifiée à +/-10 Volts

Les connexions sont situées à l'arrière de l'appareil (diamètre 0,5 pouce FPT sauf pour les versions avec pompe CP 55 dont le diamètre est alors de 3/4 pouce). Oter les protections en plastique et connecter le départ et le retour à votre application.

Pour remplir le réservoir, oter le panneau et s'assurer de la propreté et de la bonne compatibilité du fluide utilisé.

2°) MISE EN ROUTE

Avant de mettre en route vérifier le branchement électrique, les connexions entre le groupe et votre application et s'assurer que le le réservoir soit correctement rempli. Placer le bouton à l'arrière en position haute.

Pour mettre en route, appuyer sur la touche., pour éteindre appuyer à nouveau sur la même touche.

Une diode ❄️ LED s'allume pour indiquer que le groupe commence à refroidir et se met à flasher lorsque la température de consigne est presque atteinte.

3°) REGLAGE DE LA TEMPERATURE

Appuyer sur la touche du controleur de température pour sélectionner une température de consigne. Le témoin s'allume et cette température de consigne flashe. Pour en changer utiliser les flèches de réglage haut et bas jusqu'à l'obtention de la température souhaitée. Presser à nouveau pour valider. Cette nouvelle valeur flashera quelques secondes avant d'être remplacée par la température présente.

4°) MAINTENANCE PERIODIQUE

Vérifier le fluide dans le réservoir. S'il est sale veuiller rincer et le changer ou rajouter un produit tout en s'assurant de sa bonne compatibilité. La périodicité dépend des conditions locales d'utilisation.

Avant de changer le liquide s'assurer qu'on soit à une température qui ne présente aucun risque.

Nettoyer les grilles du condenseur. La périodicité dépend du degré de propreté du local. Commencer par une première inspection au bout d'un mois de fonctionnement puis espacer les vérifications s'il y a lieu.

Les pompes type PD sont munies d'un filtre de protection dont le rôle est d'empêcher des impuretés ou des corps étrangers d'endommager les corps de pompe. Pour éviter d'éventuelles pertes de charge il convient de nettoyer ces filtres. La première inspection doit s'effectuer une semaine après la mise en route de l'appareil. Ensuite nous préconisons une vérification tous les mois voire moins selon l'état dudit filtre. Avant de nettoyer ce filtre déconnecter l'appareil et vidanger.

Installazione

L'unità è dotata di un condensatore raffreddato ad aria. Il flusso d'aria per il raffreddamento viene prelevato frontalmente ed espulso posteriormente e lateralmente.

IMPORTANTE

“Posizionare lo strumento in modo da evitare l'ostruzione di tali accessi. Una ventilazione non appropriata comporterà una riduzione della capacità refrigerante ed, in casi estremi, danni al compressore.

L'apparecchiatura mantiene la massima capacità di raffreddamento con una temperatura ambiente fino a 25C° circa”.

È opportuno evitare la locazione dell'unità in ambienti troppo polverosi e provvedere periodicamente ad una pulizia del condensatore.

Assicurarsi che la tensione di alimentazione rispetti quella specificata +/- 10%.

Le connessioni idrauliche (1/2 pollici FPT o 3/4 pollici FPT con pompe idrauliche del tipo CP-55) sono posizionate ed indicate nel retro dello strumento e per accedervi rimuovere l'apposita protezione plastica.

Per accedere alla tanica di riserva del fluido rimuovere il pannello di accesso ed il relativo tappo protettivo, quindi riempire il serbatoio con l'adeguato fluido refrigerante (è possibile verificare il livello del fluido refrigerante attraverso il pannello frontale trasparente).

Per le caratteristiche del fluido riferirsi a pagina 11.

Messa in servizio

Assicurarsi che le connessioni elettriche ed il livello di riempimento del fluido refrigerante siano appropriati.

Attivare l'interruttore differenziale (locato sul retro dello strumento) spostando la leva di attuazione nella posizione alta.



Per attivare lo strumento premere .

Per disattivare lo strumento premere .

Sul pannello di controllo frontale è presente un  LED che indica lo stato di funzionamento del sistema di refrigerazione. Nel caso in cui il LED sia illuminato il sistema sta rimuovendo il calore dal fluido refrigerante.

Quando la temperatura controllata raggiunge il set-point impostato il LED continuerà a lampeggiare.

Impostazione della temperatura

Per visualizzare il set-point della temperatura premere sul controller il tasto  impostazione della temperatura . Un segnale luminoso indicherà la funzione di settaggio ed il display, ad intervalli regolari, visualizzerà il set-point che potrà essere modificato premendo .

Una volta effettuata la variazione premere il tasto di conferma per memorizzare la nuova impostazione, che verrà brevemente visualizzata sul display.

Manutenzione periodica

Ispezionare periodicamente la tanica di riserva del fluido. Se fosse necessaria una pulizia utilizzare un fluido compatibile con il sistema idraulico di circolazione ed il fluido refrigerante.

Il fluido refrigerante dovrebbe essere periodicamente sostituito in base alle condizioni ambientali ed al tempo di utilizzo.

“Prima di cambiare il fluido refrigerante assicurarsi che esso sia ad una temperatura di sicurezza”

Periodicamente soffiare il condensatore, se necessario. Anche in questo caso la frequenza dell'operazione dipende esclusivamente dalle condizioni ambientali.

Si consiglia almeno un controllo mensile visivo, dopo l'installazione, così da valutare una appropriata frequenza di pulizia.

Le unità, nelle quali sono installate delle pompe del tipo PD, sono dotate di un filtro che trattiene eventuali impurità solide evitandone il flusso attraverso la pompa stessa.

Una settimana dopo l'installazione iniziale si consiglia di pulire accuratamente questo filtro, in quanto l'intasamento di quest'ultimo potrebbe causare un incremento nella pressione di mandata della pompa. Dopo la prima pulizia controllare mensilmente le condizioni del filtro in modo da valutare un'appropriata frequenza di pulizia.

“ Prima di procedere alla pulizia del filtro disconnettere la tensione di alimentazione e svuotare il serbatoio dal fluido refrigerante tramite l'apposito scarico posizionato nel retro dell'unità”.

Kurzbedienungsanleitung





Installation

Das Gerät verfügt über ein luftgekühltes Kühlsystem. Die Luft wird an der Vorderseite angesaugt und strömt an den Seitenwänden und an der Rückseite aus. Das Gerät muß so plaziert werden, daß weder die Ansaug- noch die Ausströmöffnungen blockiert sind. Bei ungenügender Ventilation wird die Kühlleistung reduziert und kann in extremen Situationen zum Ausfall des Kühlsystems (Kompressor) führen.

Vermeiden Sie Aufstellorte mit hoher Staubentwicklung und reinigen Sie das Gerät in regelmäßigen Abständen. Um eine einwandfreie Funktion zu gewährleisten, muß das Gerät ausreichend Luft Zu- und Abfuhr haben. Bei Staub- und Schmutzablagerungen auf dem Kondensator kommt es zu einem Verlust an Kühlleistung.

Das Gerät arbeitet mit seiner maximalen Kühlleistung bis zu einer Umgebungstemperatur von ca. 25°C.

Vergewissern Sie sich, daß die Netzspannung mit der für das Gerät vorgesehenen Spannung übereinstimmt ($\pm 10\%$).

Die Schlauchanschlüsse des Gerätes befinden sich an der Rückseite und sind mit  und  bezeichnet. Die Anschlüsse haben ein 1/2 Zoll FPT Innengewinde, bzw. 3/4 Zoll FPT bei Geräten mit CP-55 Pumpe. Bitte entfernen Sie die Kunststoff-Schutzkappen von den Anschlüssen. Schließen Sie den  an den Eingang Ihres Instruments und den  an den Ausgang Ihres Instruments an.



Um das Reservoir zu füllen, öffnen Sie den Reservoir-Schutzdeckel. Entfernen Sie den

Reservoir verschluß und befüllen Sie das Reservoir mit sauberer Kühlflüssigkeit.

Geeignete Flüssigkeiten finden Sie auf Seite 11.



Inbetriebnahme

Vor Inbetriebnahme des Gerätes vergewissern Sie sich bitte nochmalig, daß die elektrischen Anschlüsse und die Rohr- u. Schlauchanschlüsse sachgemäß installiert sind und das gesamte System mit Kühlflüssigkeit gefüllt ist.

Um das Gerät einzuschalten, müssen Sie erst den Hauptschalter an der Rückseite des Gerätes auf „Ein“ stellen und dann  drücken. Zum Abschalten des Gerätes  erneut drücken.

Die LED-Anzeige an der Anzeigetafel leuchtet auf, so lange das Kühlsystem der Kühlflüssigkeit Wärme entzieht. Ist die gewünschte Temperatur erreicht (setpoint), blinkt die LED-Anzeige.

Einstellung der Temperatur

Um den Temperatursollwert anzuzeigen, drücken Sie die  Taste des Controllers. Die  LED leuchtet und die Anzeige blinkt mit dem eingestellten Sollwert. Um den Temperatursollwert zu ändern, drücken Sie Pfeiltasten, bis der gewünschte Sollwert in der Digitalanzeige angezeigt wird. Drücken Sie die  Taste erneut um den Wert zu bestätigen. Die Digitalanzeige zeigt kurz den neu eingestellten Sollwert schnell blinkend, um dann wieder die Temperatur der Kühlflüssigkeit anzuzeigen.

Wartung

Überprüfen Sie regelmäßig die Kühlflüssigkeit im Reservoir. Sollte eine Reinigung notwendig sein, spülen Sie das Reservoir mit einer speziellen Reinigungsflüssigkeit, die für das Leitungssystem und die Kühlflüssigkeit geeignet ist.

Das Kühlmittel sollten Sie in regelmäßigen Abständen erneuern. Wenn Sie das Gerät bei niedrigen Temperaturen betreiben, erhöht sich mit der Zeit der Wasseranteil in der Kühlflüssigkeit. Dies führt zum Verlust von Kühlkapazität.

Vor dem Austausch der Kühlflüssigkeit erhöhen Sie bitte die Betriebstemperatur des Gerätes so weit, daß die Kühlpulen eisfrei sind.

Regelmäßiges Absaugen des Kühlkörpers ist erforderlich. Die Reinigungshäufigkeit hängt von der Betriebsumgebung ab. Eine monatliche Überprüfung des Kondensators ist empfehlenswert. So werden Sie nach einigen Monaten einen Reinigungsrythmus gefunden haben.

Geräte mit PD-Pumpen sind mit einem Pumpenfilter ausgestattet. Der Filter verhindert, daß kleine Teilchen und Schmutzablagerungen in die Pumpe gelangen und so die Pumpenflügel beschädigen. Ein verstopfter Filter führt zu einem erhöhten Druckverlust.

Nach der ersten Installation kann es zu einer Verunreinigung des Filters kommen. Die erste Reinigung sollte daher nach einer Woche erfolgen. Danach empfehlen wir eine monatliche Überprüfung des Filters. So können Sie nach einiger Zeit abschätzen, wie oft der Filter gereinigt werden muß.

Bevor Sie den Filter reinigen, ziehen Sie den Netzstecker und entleeren Sie das Gerät.

Verkorte handleiding

Installatie

Het apparaat heeft een luchtgekoeld koelsysteem. De luchtinlaat is aan de voorzijde. De luchtuitlaat is aan de twee zijkanten en aan de achterzijde. Plaats het apparaat zo dat de luchtaanvoer niet geblokkeerd is. Bij onvoldoende luchtdoorstroming zal het koelvermogen afnemen. In extreme gevallen zal de compressor uitvallen.

Plaats het apparaat niet in stoffige ruimtes. Maak het apparaat regelmatig schoon. Voor een goede werking moet het apparaat voldoende lucht door de condensor laten stromen. Een ophoping van stof of andere deeltjes zullen het koelvermogen nadelig beïnvloeden.

Het apparaat zal de opgegeven specificaties halen tot een omgevingstemperatuur van ongeveer +77°F (+25°C).

Het voltage moet voldoen aan het opgegeven voltage, $\pm 10\%$.

De aansluitingen voor de waterslangen zijn gelabeld en bevinden zich aan de achterzijde. De aansluitingen zijn 1/2 inch FPT (3/4 inch FPT voor apparaten met een CP-55 pomp). Verwijder de plastic beschermdopjes die zich in de aansluitingen voor de waterslangen bevinden. Sluit de "Outlet" van het apparaat aan op de "Inlet" van uw toepassing. Sluit de "Inlet" van het apparaat aan op de "Outlet" van uw toepassing

Verwijder het paneel wat toegang geeft tot de vulopening van het vloeistofreservoir. Verwijder de dop van het vloeistofreservoir en vul het reservoir met schone vloeistof.

Voor aanbevelingen over vloeistoffen verwijzen wij naar pagina 11.

In bedrijf stellen

Check, voor het opstarten, alle aansluitingen. Overtuig u ervan dat het apparaat op de juiste manier is gevuld met koelvloeistof. Aan de achterzijde van het apparaat bevindt zich de schakelaar voor de zekering. Deze schakelaar moet naar boven staan.

Om het apparaat te starten druk op "start/stop". Om het apparaat uit te schakelen druk nogmaals op "start/stop".

De ❄️ LED geeft de status van het koelsysteem aan. De LED gaat aan als het apparaat warmte onttrekt aan de koelvloeistof. Op het moment dat de ingestelde temperatuur wordt bereikt zal de LED gaan knipperen.

Temperatuur Instelling

Druk op de controller om de ingestelde temperatuur te zien. De indicator licht op en de ingestelde waarde knippert. Druk op de knop met het pijltje totdat de gewenste temperatuur is ingesteld. Druk nogmaals op de knop met het pijltje om de wijziging te bevestigen. De display knippert enkele malen snel en zal dan weer de actuele temperatuur laten zien.

Periodiek onderhoud

Controleer regelmatig de vloeistof. Als de vloeistof ververst moet worden handel dan als volgt:

Laat de vloeistof uit het apparaat lopen. Aan de achterzijde van het apparaat bevindt zich een afvoerkraantje.

Spoel het reservoir door met een spoelvloeistof die geschikt is voor het apparaat en de koelvloeistof.

Het is noodzakelijk om de ribben van de condensor regelmatig schoon te maken met behulp van een stofzuiger. Check de condensor maandelijks. Na enige maanden kunt u de frequentie van het schoonmaken bepalen.

Apparaten met een PD pomp hebben een filter. Het filter beschermt de pomp tegen deeltjes die in het vloeistofcircuit kunnen komen. Een vies filter zal de druk in het koelcircuit verhogen.

Na de eerste opstart is er een verhoogde kans op een vervuild filter. **Maak na één week het filter schoon.** Wij adviseren een maandelijks inspectie van het filter. Na een aantal maanden kunt u de frequentie van inspecties aanpassen. Haal de stekker uit het stopcontact voordat u het filter gaat schoonmaken.

Stručný návod k obsluze



Instalace

Jednotka je chlazená vzduchem. Vzduch je nasáván předním panelem a je odváděn bočními panely a zadním panelem. Vždy umístěte jednotku tak, aby nebyl kladen odpor proudění vzduchu. V opačném případě dojde ke snížení chladicího výkonu a v extrémních případech i k poruše kompresoru.

Je třeba se vyvarovat nadměrně prašného prostředí a stanovit a dodržovat interval pravidelného čištění kondenzátoru. Pro správnou funkci jednotky je třeba, aby kondenzátorem proudilo dostatečné množství vzduchu. Úsady prachu a nečistot na žebrech kondenzátoru se projeví snížením chladicího výkonu.

Jednotka je schopna podávat deklarovaný chladicí výkon až do okolní teploty +25°C.

Napájecí napětí nesmí překročit nominální hodnotu $\pm 10\%$.

Připojení okruhu cirkulační kapaliny se provádí pomocí přípojek umístěných na zadním panelu jednotky. Přípojky jsou označeny  a . Rozměr fittingů je 1/2" FPT (3/4" FPT pro jednotky s čerpadlem CP-55). Vyjměte plastové ochranné vložky z obou nátrubků. Připojte přívod a odvod vaší aplikace, t.j. externího zařízení které temperujete na požadovanou teplotu.

Plnění rezervoáru se provádí po otevření přístupového panelu a vyšroubování zátky rezervoáru. Rezervoár se poté naplní vhodnou cirkulační kapalinou.

Doporučené parametry cirkulační kapaliny jsou specifikovány na straně 11.

Provoz

Před zahájením provozu je třeba opakovaně prověřit elektrické připojení a cirkulační obvody jednotky. Cirkulační obvod musí být zaplněn vhodnou cirkulační kapalinou. Sítový spínač na zadní stěně jednotky poté umístíme do horní polohy.

K zahájení provozu stiskněte . K vypnutí jednotky opět stiskněte .

 LED kontrolka indikuje stav chladicího systému. Pokud svítí, signalizuje že chladicí systém momentálně běží a odvádí teplo cirkulační kapalině. Pokud se teplota cirkulační kapaliny přiblíží požadované operační teplotě, kontrolka začne blikat.

Nastavení teploty

Po zapnutí jednotky se zobrazí požadovaná teplota cirkulační kapaliny. Po stisknutí kontrolního tlačítka displej začne blikat. Šípkami nahoru nebo dolů nastavíte, pokud je třeba, novou požadovanou teplotu. Změna se potvrdí opětovným stisknutím kontrolního tlačítka. Po potvrzení se zobrazí nově požadovaná hodnota rychlým blikáním displeje, poté se zobrazí aktuální teplota externí cirkulační kapaliny.

Pravidelná údržba

Pravidelně kontrolujte stav a kvalitu kapaliny v rezervoáru. Pokud je třeba provést vyčištění, použijte kapalinu, která je shodná nebo kompatibilní s používanou cirkulační kapalinou.

Cirkulační chladicí kapalinu je třeba pravidelně obměňovat. Interval obměny závisí na stávajících podmínkách a stupni zatížení. Před výměnou cirkulační kapaliny se prosím ujistěte, že nemá nebezpečnou teplotu.

Nezbytnou nutností je pravidelné čištění žebek kondenzátoru pomocí vysavače. Interval čištění závisí na podmínkách. Výrobce doporučuje provádět vizuální kontrolu a případné čištění chladicích žebek kondenzátoru každý měsíc. Po čase se na základě zkušenosti stanoví optimální termín čištění, který je třeba důsledně dodržovat.

Jednotky s PD čerpadly mají v okruhu cirkulační kapaliny zařazen filtr. Filtr má za úkol zachycovat mechanické nečistoty a zabránit tak poškození lopatek čerpadla. Zanesený filtr způsobí zvýšení tlaku cirkulační kapaliny.

Při prvním uvedení do provozu se může filtr snadno zanášet. **Po uplynutí jednoho týdne od uvedení do provozu je třeba filtr vyčistit.** Další kontrola a čištění filtru se doporučuje v měsíčních intervalech. Po několika měsících se na základě zkušenosti stanoví vhodný interval kontroly čistoty filtru. Před čištěním odpojte přívodní kabel od zdroje elektrické energie a vypusťte z jednotky cirkulační kapalinu.

Forenklet brukermanual

Innstallasjon

Kjøleren er ett luftkjølt system.

Luften går inn foran, og går ut på siden og bak kjøleren.

Plasser derfor alltid kjøleren så det er god plass rundt.

Dårlig luftgjennomstrømning vil kunne forårsake dårlig kjølekapasitet og i verste fall kan det forårsake skader på kompressoren.

Kjøleren bør ikke plasseres i ekstremt skitne rom, og periodevis rengjøring må utføres.

Lag gjerne et skjema, og heng det nær kjøleren.

For at kjøleren skal virke ordentlig, trenger den stor luftgjennomstrømning i kondensator.

Når kondensatoren tettes med støv, eller det blir varmere enn 25°C i rommet, vil dette føre til tap av kjølekapasitet.

Kjøleren har full kjølekapasitet opp til 25°C (77°F) rom temperatur.

Vær sikker på at strøm, spenning møter de spesifiserte verdier $\pm 10\%$.

Rørtilkoblinger er plassert bak på kjøleren og er påsatt propper for beskyttelse.

Størrelsen på rør tilkoblinger er 1/2" inch FPT gjenger (3/4" inch FPT gjenger for kjølere med CP 55 pumpe).

Ta bort plastikkpropper fra begge kuplingene, og tilkoble deretter rørene.

Ut fra kjøler til inntak på applikasjonen.

Inn på kjøler fra uttak på applikasjonen.

For å fylle systemet.

Åpne deksel for reservoar og skrukork på reservoaret.

Fyll opp med ren kjølevæske/vann.

For anbefalt kjølevæske, se side 11.

Operasjon

Før start av kjøleren, dobbelsjekk at alle elektriske og rørtilkoblinger er korrekt tilkoblet.

Kontrollør at vannsystemet er fylt opp med anbefalt kjølevæske. Sett på strømmen ved å slå på bryter på baksiden av kjøleren.

For å starte kjøleren,- trykk. For å slå av kjøleren,- trykk igjen.

LED lyset indikerer status på kjøleren. Den lyser når kjøleren fjerner varme fra vannet.

Når temperaturen nærmer seg settpunktet, begynner LED lyset å blinke.

Temperatur settpunkt justering.

For å programmere kontrolleren,- trykk på kontrolleren. Indikatorlampen vil nå lyse og nummerdisplayet blinke den satte sett-temperatur. For å forandre verdien, trykk piltast opp eller ned til ønsket verdi blinker i displayet. Trykk igjen for å bekrefte den nye verdien.

Displayet vil nå blinke den nye verdien en liten stund og deretter gå tilbake til den avleste temperaturen.

Periodisk vedlikehold

Kontrollør væsknivået i reservoaret periodisk. Rengjør reservoaret ved behov.

Spyl reservoaret med rengjøringsmiddel som er kompatibelt med systemet og væske som skal brukes som kjølevæske.

Kjølevæsken i systemet bør skiftes med periodiske mellomrom. Frekvensen på skifte beror på bruken av systemet.

Før kjølevæsken skiftes må, kjølevæske temperaturen være på ett sikkert nivå.

Periodisk rengjøring av kondensatoren er strengt nødvendig. Anbefalt frekvens, kontrollør kondensatoren en gang pr. mnd. etter installasjon.

Deretter rengjøres kondensatoren jevnlig med samme intervall.

Kjølere med PD pumper er utstyrt med sil. Dersom det er partikler i systemet, beskytter silen mot ødeleggelser.

Etter noe tid, bør man kontrollere/rengjøre dette filteret, deretter kontrollør/rengjør filteret jevnlig.

Tett filter vil forårsake lavere trykk i sirkulasjons systemet.

Chapter 1 Description

The Thermo Scientific NESLAB Merlin Recirculating Chiller is designed to provide a continuous supply of cooling fluid at a constant temperature and volume. The unit consists of an air-cooled refrigeration system, plate heat exchanger, recirculating pump, polyethylene reservoir, and a microprocessor controller.

Throughout the manual, you will be asked to consult the unit's name plate label for specific information. The label is located on the rear of the unit. See below for an example.



Specifications

	M 25	M 33	M 75	M 100	M 150
Process Fluid					
Temperature Range					
Standard Temp Units	NA	NA	+5°C to +35°C	+5°C to +35°C	+5°C to +35°C
Low Temp Units	-15°C to +35°C	-15°C to +35°C	-15°C to +35°C	-15°C to +35°C	-15°C to +35°C
Temperature Stability^{1,2}	±0.1°C	±0.1°C	±0.1°C	±0.15°C	±0.15°C
Reservoir Volume					
Gallons	0.5	0.5	0.5	0.5	0.5
Liters	1.8	1.8	1.8	1.8	1.8
Refrigerant	R134a	R134a	R134a	R404a	R404a
Intake Requirements (ft³/min) (60 Hertz units)	178	178	385	755	755
Shipping Weight					
(Pounds)	141	141	200	287 ³	287 ³
(Kilograms)	64	64	91	130	130

Standard Temp Units Cooling Capacity²

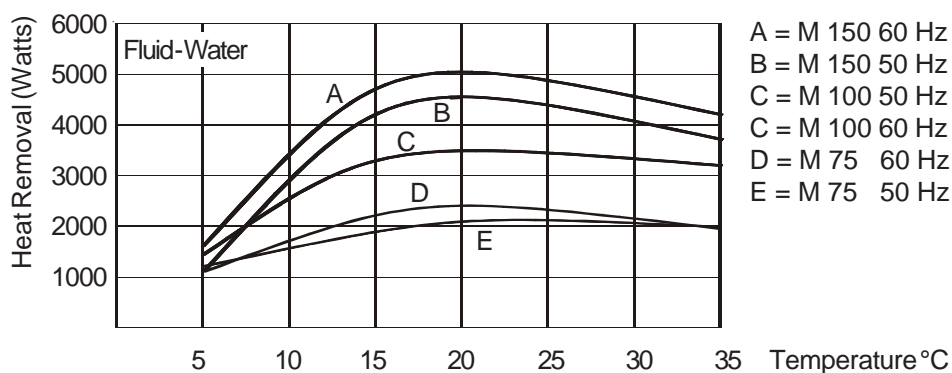

1. At the chiller. Display resolution 1.0°C. 0.1°C display resolution is available using the controller's Setup/Tuning Loop, see page 18.
2. Circulating at 20°C ambient, pump unloaded. Cooling capacity will vary depending on fluid temperature, ambient temperature, and cooling fluid.
3. Units with PD 2 pumps. Units with CP 55 pumps weigh 310 pounds (141 kilograms).
4. Thermo Fisher Scientific reserves the right to change specifications without notice.

**LowTempUnits
Cooling Capacity²**

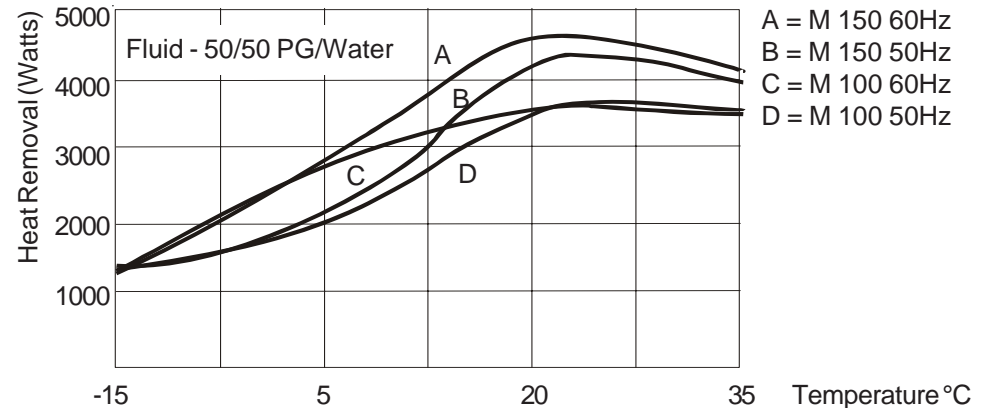
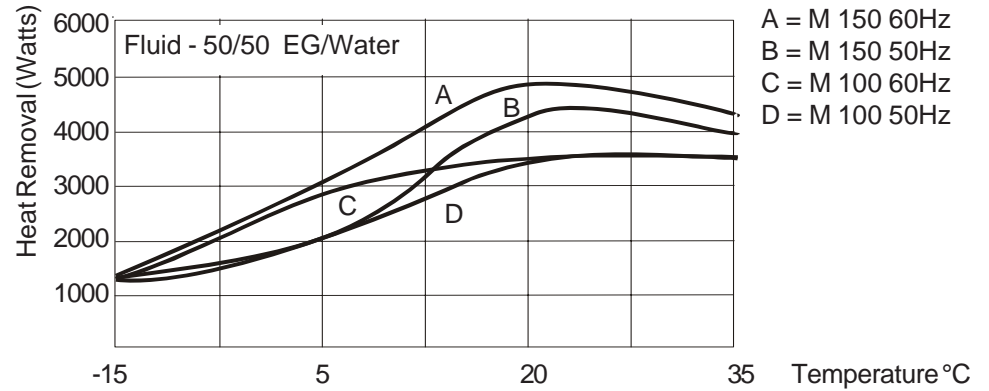
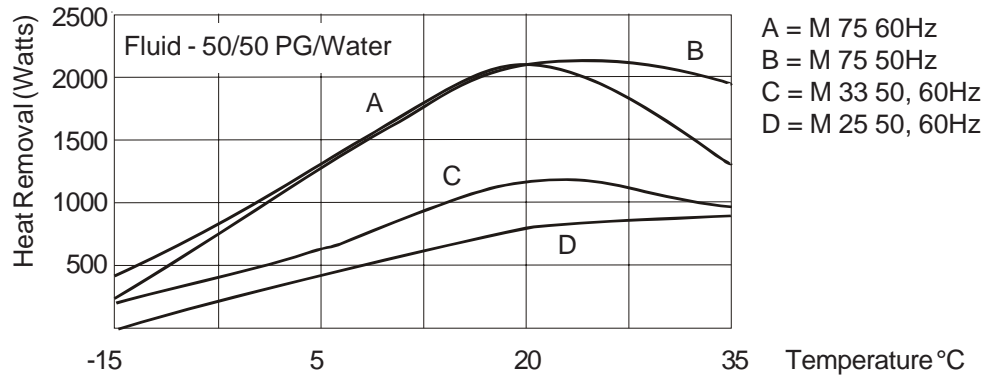
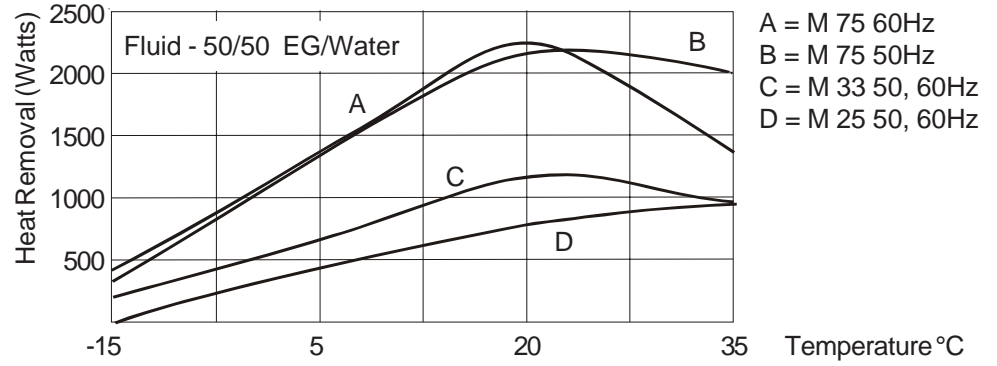

Pump Options**Standard temperature range units**

Unit	Standard	Optional
M 75	PD 1	PD 2
M 100 (208/230V 60Hz)	PD 2	CP 55
M 100 (230V 50Hz)	PD 2	None
M 100 (400V 50Hz)	PD 2	CP 55
M 150 (208/230V 60Hz)	PD 2	CP 55
M 150 (230V 50Hz)	PD 2	None
M 150 (400V 50Hz)	PD 2	CP 55

Low temperature range units

Unit	Standard	Optional
M 25	PD 1	None
M 33	PD 1	PD 2
M 75	PD 2	None
M 100 (208/230V 60Hz)	PD 2	CP 55
M 100 (230V 50Hz)	PD 2	None
M 100 (400V 50Hz)	PD 2	CP 55
M 150 (208/230V 60Hz)	PD 2	CP 55
M 150 (230V 50Hz)	PD 2	None
M 150 (400V 50Hz)	PD 2	CP 55

NOTE PD pumps should not be used with applications that are sensitive to high pressures. ▲

Pumping Capacities

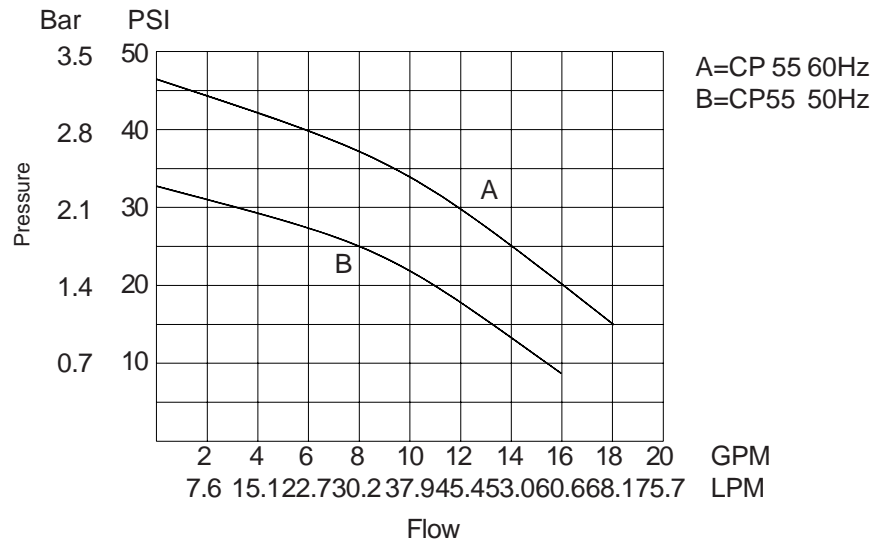
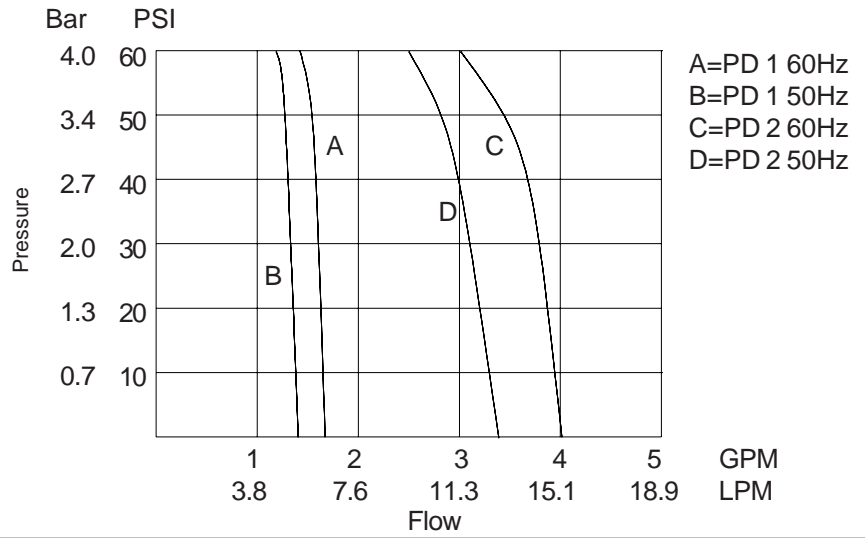

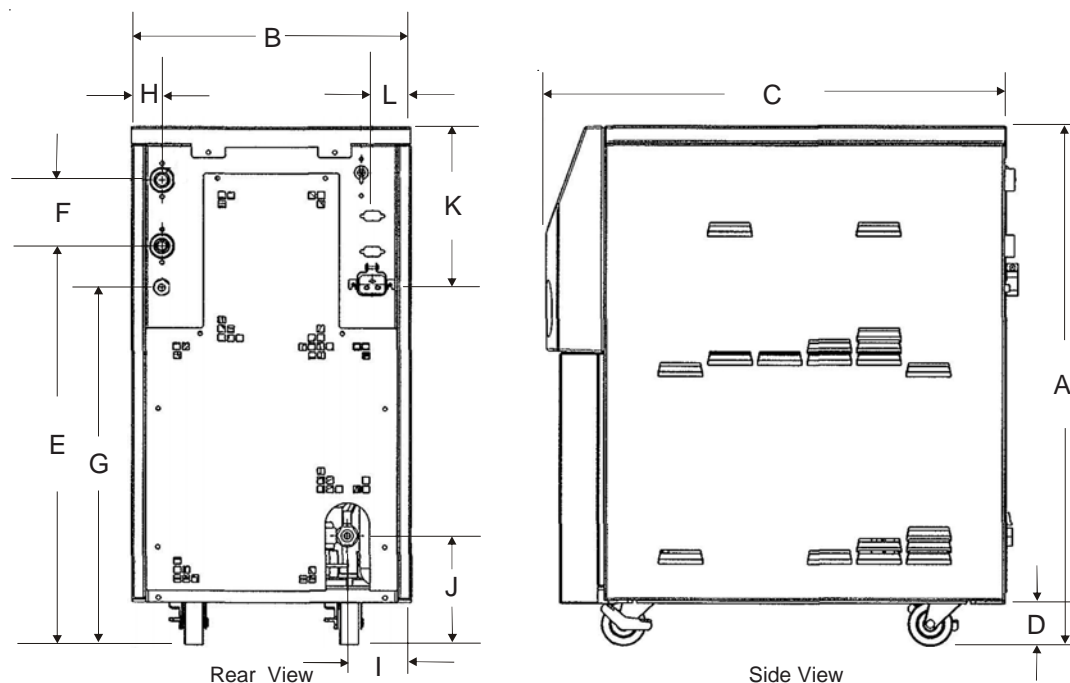

Unit Dimensions (Inches)	M 25	M 33	M 75	M 100	M 150
Dimension A ¹	23 1/2	23 1/2	26 1/8	30 3/8	30 3/8
Dimension B ¹	12 5/8	12 5/8	16 1/4	21 1/4	21 1/4
Dimension C ¹	20 7/8	20 7/8	24	29 1/4	29 1/4
Dimension D ²	2	2	2	3	3
Dimension E ³	18 1/8	18 1/8	20 3/4	25	25
Dimension F ⁴	3	3	3	3	3
Dimension G ⁵	16 1/4	16 1/4	18 7/8	23	23
Dimension H ⁶	1 3/8	1 3/8	1 3/8	1 3/8	1 3/8
Dimension I ⁷	2 7/8	2 7/8	3 5/8	4 3/4	4 3/4
Dimension J ⁸	5	5	7	7 1/2	7 1/2
Dimension K ⁹	7 1/8	7 1/8	7 1/8	7 1/8	7 1/8
Dimension L ¹⁰	1 3/4	1 3/4	1 3/4	1 3/4	1 3/4
Crate Dimensions (H x W x D) ¹¹	36 x 18 1/2 x 26	36 x 18 1/2 x 26	39 x 22 1/4 x 29 1/4	42 x 27 x 35 1/4	42 x 27 x 35 1/4

1. Dimension A is the height of the unit. Units with CP-55 pumps are 6" higher. The unit width and depth (dimensions B and C) are the case dimensions, add approximately 1/2 inch to include the plumbing connections.
2. Dimension D is the distance from the floor to the bottom of the unit case (height of the casters).
3. Dimension E is the distance from the floor to the center of the outlet connection.
4. Dimension F is the distance between the center of the outlet and inlet connections.
5. Dimension G is the distance from the floor to the center of the pressure relief valve (units with PD pumps).
6. Dimension H is the distance from the unit's side to the center of the outlet/inlet connections, and the pressure relief valve. 2" from the unit's side to the center of the outlet/inlet connections for M-100/150 units with CP-55 pumps.
7. Dimension I is the distance from the unit's side to the center of the drain connection. 5 1/4" for M-100/150 units with CP-55 pumps.
8. Dimension J is the distance from the floor to the center of the drain connection. 7 1/2" for M-100/150 units with CP-55 pumps.
9. Dimension K is the distance from the top of the unit to the center of the power connection.
10. Dimension L is the distance from the unit's side to the center of the power connection. NA for M-100/150 units rated 400V/50Hz.
11. Crate dimensions for units with CP-55 pumps are 6 inches higher. All packages tested to ISTA 2B.

Chapter 2 Installation and Operation

Site	Ambient Temperature Range*	10°C to 35°C (50°F to 94°F)
	Relative Humidity Range	10% to 80% (non-condensing)
	Operating Altitude	Sea Level to 6000 feet (1830 meters)
	Overvoltage Category	II
	Pollution Degree	2

*The unit retains its full rated capacity in ambient temperatures up to approximately 25°C (77°F). Reduce the cooling capacity 1% for every 0.5°C (1°F) above 25°C (77°F), up to a maximum ambient temperature of 35°C (94°F).



Never place the unit in a location where excessive heat, moisture, or corrosive materials are present. ▲

The unit has an air-cooled refrigeration system. Air is drawn through the front of the unit and discharged through rear and side panels. The unit must be positioned so the intake and discharge are not impeded. A minimum clearance of 3 feet (1 meter) on all vented sides is necessary for adequate ventilation. Inadequate ventilation will cause a reduction in cooling capacity and, in extreme cases, compressor failure.

Direction of Airflow

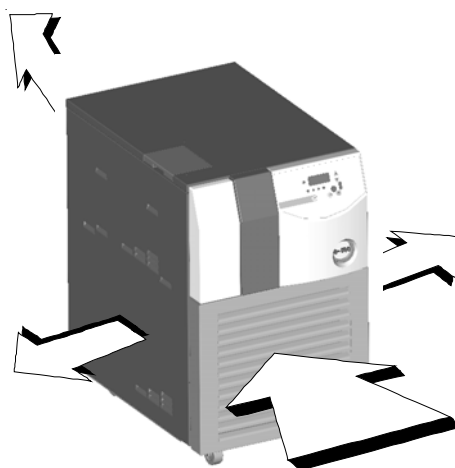

Excessively dusty areas should be avoided and a periodic cleaning schedule should be instituted (see Chapter 4, Maintenance). Optional air filters are available, contact our Service Department. See Preface, After-Sale Support.

Electrical Requirements



The unit construction provides protection against the risk of electrical shock by grounding appropriate metal parts. The protection may not function unless the power cord is connected to a properly grounded outlet. It is the user's responsibility to assure a proper ground connection is provided. ▲

The user is responsible to ensure that the power cord provided meets local electrical codes. If not, contact qualified installation personnel.

The unit is intended for use on a dedicated outlet. The Merlin has an internal circuit protection that is equivalent (approx.) to the branch circuit rating. This is to protect the Merlin, and is not intended as a substitute for branch circuit protection.

Standard and Low-Temperature 60 Hertz units available power options:

Unit	Pump	Voltage	Current Value	Line Cord Plug
M 25	PD 1	115	9.8	5-15P
M 33	PD 1	115	13.2	5-20P
	PD 2	115	15.5	5-20P
	PD 1	208/230	6.5	6-15P
	PD 2	208/230	7.8	6-15P
M 75	PD 1	208/230	8.8	6-15P
	PD 2	208/230	10.1	6-15P
M 100	PD 2	208/230	13.1	L6-30P
	CP 55	208/230	16.1	L6-30P
M 150	PD 2	208/230	15.4	L6-30P
	CP 55	208/230	18.4	L6-30P

NOTE All 60 Hertz units are UL Listed and Certified to Canadian Standards. ▲

Amperage based on extreme operating conditions. Operating in a 20°C ambient and at nominal voltage will result in a lower amperage draw.

Refer to the name plate label on the rear of the unit for specific electrical requirements.

NOTE Three-phase units are not supplied with a line cord. Instructions for wiring three-phase units are located behind the power box cover. To access the power box remove the unit's top and left-side panel. Remove the screws securing the cover. ▲

Standard and Low-Temperature 50 Hertz units:



Unit	Pump	Voltage	Current Value	Line Cord Plug
M 25	PD 1	230	5.1	Country Specific
M 33	PD 1	230	6.3	Country Specific
	PD 2	230	7.6	Country Specific
M 75	PD 1	230	8.8	Country Specific
	PD 2	230	10.1	Country Specific
M 100	PD 2	230	13.5	Country Specific
	PD 2	400/3Ø/5W	7.7	Country Specific
	CP 55	400/3Ø/5W	5.5	Country Specific
M 150	PD 2	230	15.6	Country Specific
	PD 2	400/3Ø/5W	7.7	Country Specific
	CP 55	400/3Ø/5W	5.5	Country Specific

Amperage based on extreme operating conditions. Operating in a 20°C ambient and at nominal voltage will result in a lower amperage draw.

Refer to the name plate label on the rear of the unit for specific electrical requirements.

NOTE Three-phase units are not supplied with a line cord. Instructions for wiring three-phase units are located behind the power box cover. To access the power box remove the unit's top and left-side panel. Remove the screws securing the cover. ▲

Plumbing Requirements



The plumbing connections are located on the rear of the unit and are labeled  (supply) and  (return). The connections are 1/2 inch Female Pipe Thread. For units with CP-55 pumps, the connections are 3/4 inch Female Pipe Thread. Units with 1/2 inch fittings are supplied with 3/8 inch and 1/2 inch barbed adapters, units with 3/4 inch fittings are supplied with 1/2 inch and 3/4 inch barbed adapters.

Remove the plastic protective plugs from both plumbing connections. If requires, install the barbed adapters to these connections.

Do not install the adapters or your fittings dry. Use two wraps of Teflon[®] tape on the male thread wound in a clockwise direction while facing the thread, or a suitable Teflon[®] sealant/lubricant. The 1/2" male connection can be tightened 2 full turns $\pm 1/4$ turn, and the 3/4" male connector can be tightened 2 1/2 to 3 turns to seal. Overtightening will damage the female thread.

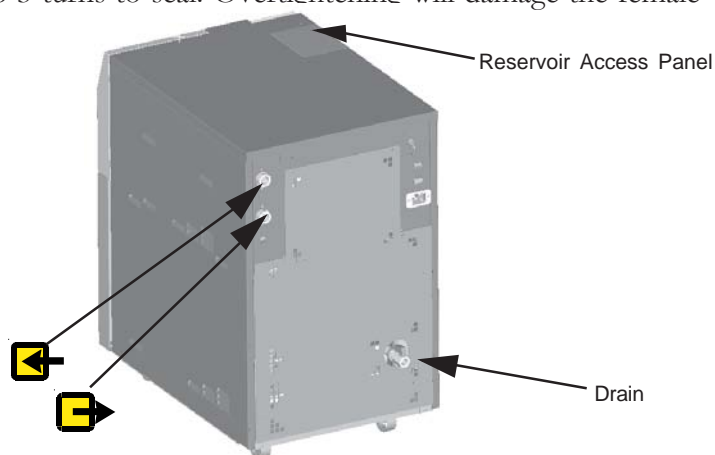
Plumbing Connections



Connect  to the hose feeding the inlet of your application. Connect  to the hose from the outlet of your application. Clamp all connections.



Never connect the fittings to your building water supply or any water pressure source. ▲

NOTE On units equipped with PD pumps, ensure your plumbing is rated to withstand 110 psi at the highest operating temperature. ▲

It is important to keep the distance between the unit and the instrument being cooled as short as possible. Tubing should be straight and without bends. If diameter reductions must be made, they should be made at the inlet and outlet of your application, not at the chiller.

All units have a ball-valve reservoir drain located on the rear of the unit. Add the desired length of tubing to the drain valve. To help prevent any spillage from your application, consider installing external isolation valves on the supply and return lines.

Fluids



Never use flammable or corrosive fluids with this unit. Do not use automotive antifreeze. Commercial antifreeze contains silicates that can damage the pump seals. Use of automotive antifreeze will void the manufacturer's warranty. ▲

Acceptable fluids and their normal operating temperature ranges are:

- Filtered/Single Distilled water, +5°C to +35°C (+10°C to +35°C for low-temperature units)
- 50/50 Uninhibited Ethylene Glycol/Water, -15°C to +35°C
- 50/50 Inhibited Ethylene Glycol/Water, -15°C to +35°C
- 50/50 Uninhibited Propylene Glycol/Water, -15°C to +35°C
- 50/50 Inhibited Propylene Glycol/Water, -15°C to +35°C
- Deionized water (1 - 3 MΩ cm, compensated), +5°C to +35°C (+10°C to +35°C for low-temperature units)



Ethylene glycol (EG) is hygroscopic, it will absorb water from its environment. This can affect the freezing point and boiling point of the fluid over time. This may result in system failure. ▲



When using EG/water or PG/water, top-off with EG/water or PG/water. Do not top-off with plain water. Topping-off with plain water can severely affect the freezing point and boiling point of the fluid. This may result in system failure. ▲



Do not use a Deionization (DI) filter with Inhibited EG or Inhibited PG. A DI filter will remove inhibitors from the solution rendering the fluid ineffective against corrosion protection. Also, inhibitors increase fluid conductivity. ▲

Refer to Appendix A for additional information.

Filling Requirements

The polyethylene reservoir is translucent for easy fluid level monitoring. Remove the reservoir access panel, see previous page. Locate and remove the reservoir cap. Fill the reservoir with clean cooling fluid.

Since the reservoir capacity may be small compared to your application, have extra cooling fluid on hand to keep the system topped off when external circulation is started.

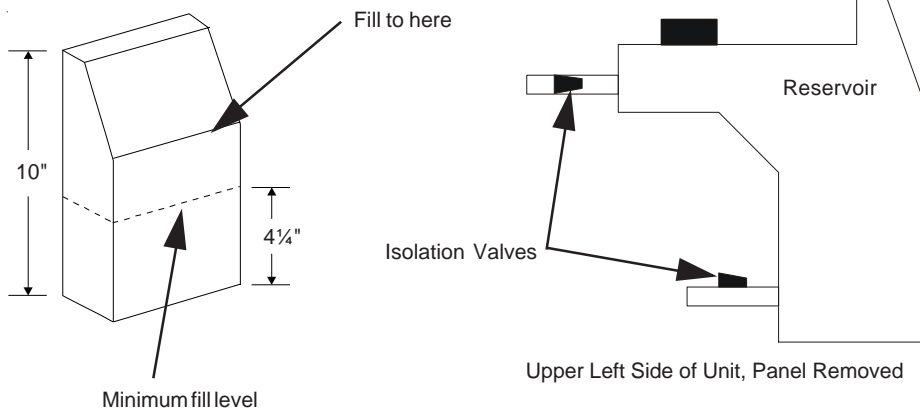

Reservoir Tank Isolation Valves Open Tank Circulation

Units are equipped with two reservoir tank isolation valves. The valves are used to isolate the tank from the fluid flow. The units are factory shipped with the valves open.

Ensure the valves are open when circulating to a closed system. When operating at low temperatures and circulating to a closed system, should condensation appear on the reservoir, closing the upper valve *after initial start up* will help eliminate it. Leave the valve open for initial start up so process fluid flow through the reservoir can rapidly bleed air from the system. To close the upper valve, open the reservoir access panel and turn the valve 90°.



System temperature changes with the isolation valves closed, and while circulating to a closed system, can create a vacuum and/or high pressure conditions. ▲

If your application requires the process fluid to flow to an open tank located above the unit, before starting close the valves to prevent fluid siphoning and reservoir overflow. To close the upper valve, open the reservoir access panel, to close the lower valve you must remove the side access panel. Turn the valves 90°.

Controller

The controller controls temperature using a Proportional-Integral-Derivative (PID) algorithm. It is designed with self-diagnostic features and easy to use operator interface.

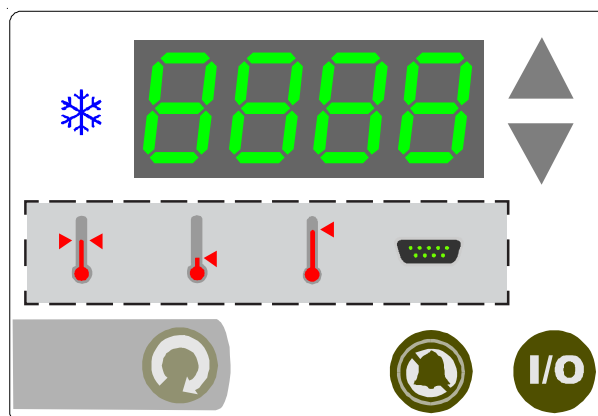

Use this key to toggle the **unit on or off**.



Use this key to **scroll** through the controller's LEDs. It is also used to accept and save changes.



If the alarm sounds, use this key to toggle the **alarm off and on**. **NOTE:** If the cause of the alarm is cleared but then reoccurs, the alarm will sound again.



Use this key to **increase displayed numerical values**.



Use this key to **decrease displayed numerical values**.





Indicates **refrigeration system status**. It illuminates to indicate the refrigeration system is removing heat from the cooling fluid. As the operating temperature approaches the temperature setpoint, the LED will flash. The indicator is off when heat is not being removed.

NOTE The following indications are not visible until  is depressed. ▲



 Indicates the controller is displaying the **setpoint**. Adjust the display value using the arrow keys.

NOTE You cannot adjust the setpoint closer than 2°C to either of the temperature limits discussed below. ▲

 Indicates the controller is displaying the **low temperature alarm** setting. The indicator flashes and the alarm sounds if this limit is exceeded. Adjust the display value using the arrow keys.

 Indicates the controller is displaying the **high temperature alarm** setting. The indicator flashes and the alarm sounds if this limit is exceeded. Adjust the display value using the arrow keys.

 **(Optional)** Indicates the unit is in the **remote/serial communication** mode of operation. The indicator flashes if the unit is in the remote start/stop mode of operation. Toggle between the local and remote modes using the arrow keys.

NOTE For all four indicators, if neither arrow key is pressed within 10 seconds the display will return to the recirculating temperature display. Save any change using . After pressing an arrow key, if  is not pressed within 60 seconds the display will return to the recirculating temperature display and ignore any change. ▲

Start Up/Shut Down

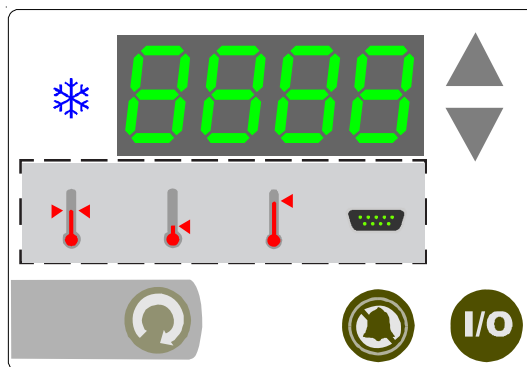

Pre-Start

Before starting the unit, double check all electrical and plumbing connections. Ensure the power cord is secured to the rear of the unit. Have extra recirculating fluid on hand. If the unit will not start refer to Chapter 5 Troubleshooting.

Circuit Protector

Place the circuit protector located on the rear of the unit to the up position, the controller will flash and the alarm will momentarily sound.





The unit has automatic restart. If the unit was shutdown as a result of a power failure and power is restored, it will restart. ▲

Starting

Press . The controller will do a self-test (the controller will quickly sequence through its LEDs and momentarily sound the alarm) and then display the recirculating fluid temperature. The refrigeration system and the recirculation pump will then start. The RECIRCULATING PRESSURE gauge will display the pump operating pressure. If the pressure needs adjusting, refer to page 29.

NOTE If on start up the unit's recirculating fluid is outside either temperature limit, the unit will operate but the appropriate indicator will flash until the fluid is within the limit. ▲

Setpoint



To display/change the setpoint press  until  illuminates. The display will flash the current setpoint value. Use the arrow keys to change the value.

NOTE If the arrow keys are not pressed within 10 seconds the display will return to the current reservoir temperature. The controller will not allow you to enter a setpoint closer than 2°C of either temperature alarm setting discussed on the next page. Trying to use a setpoint within 2°C causes the appropriate indicator to flash and sounds the audible alarm twice. ▲

Once the desired setpoint is displayed, press  again to confirm the change. The display will rapidly flash the new value for a short period and then return to the recirculating fluid temperature.

NOTE If the value is not confirmed within 60 seconds the display will return to the recirculating fluid temperature and ignore any changes. ▲

Temp Alarms



To display/change the temperature alarm setting press  until either  or  illuminates. The display will flash the current limit value. Use the arrow keys to change the value. The low-end range is 0°C (-15°C for low-temp units) to 30°C. The high-end range is 10°C to 40°C.

NOTE If the arrow keys are not pressed within 10 seconds the display will return to the current reservoir temperature. You cannot set either alarm closer than 2°C of the setpoint. ▲

Once the desired setting is displayed, press  again to confirm the change. The display will rapidly flash the new value for a short period and then return to the recirculating fluid temperature.

NOTE If the value is not confirmed within 60 seconds the display will return to the recirculating fluid temperature and ignore any changes. ▲

Remote/Serial Comm

(Optional) Once your remote/serial comm cable is connected to the unit, enable or disable remote operation or serial communication by pressing  until  illuminates. The display will flash the communication status. Use the up arrow key to enable, the down arrow to disable. See pages 21 and 22 for additional information.



NOTE If the arrow keys are not pressed within 10 seconds the display will return to the current reservoir temperature. ▲

Once the desired status is displayed, press  again to confirm the change. The display will rapidly flash the new status for a short period and then return to the recirculating fluid temperature.

NOTE If the status is not confirmed within 60 seconds the display will return to the recirculating fluid temperature and ignore any change. ▲

NOTE Enabling serial communications disables the remote start/stop feature. In either mode, the setpoint and alarm values can not be changed using the controller but they can still be viewed. ▲

External Sensor

(Optional) Once the external sensor cable is connected to the unit, enable or disable the sensor by pressing  a fifth time. The display will alternate with *rPrtb* and either *ON* or *OFF*. If desired, use the arrow keys to change the status and then press  to return to the temperature display. See page 23 for additional information.

Stopping

To turn the unit off, press .

When the display goes blank it is safe to place the circuit protector located on the rear of the unit to the down position.



Using any other means to shut the unit down can reduce the life of the compressor. ▲



The circuit protector located on the rear of the unit is not intended to be used as a disconnecting means. ▲



Always turn the unit off and disconnect it from its supply voltage before moving the unit. ▲

Setup/Tuning Loop

The Setup/Tuning Loop, see illustration next page, is used to configure the controller temperature display and various operating parameters. To enter the loop you must be displaying the reservoir fluid temperature and then, while pressing and holding \blacktriangledown , press \odot . The display will indicate t_{TEMP} . Use the arrow keys to enter/bypass the loop. Once in the loop press \odot to sequence through it. Use the arrow keys to change any display.

The loop is used to determine how the unit will react when a fault occurs ($FLTS$) — either shut down (OFF) or continue to run (ON). The unit is shipped configured to run.

It is also used to configure the temperature displays to indicate to a tenth of a degree (t_{TEMP}).

The loop is used to select which temperature sensor the high and low temperature monitors will use ($TEMP$). $temp1$ is the internal sensor, $temp2$ is the optional external sensor. $temp2$ is displayed only if the optional external sensor is enabled.

If the optional external/remote probe is enabled, the loop is used to set the remote probe temperature deviation ($TEMPD$) limit. This limit is applied to the setpoint to calculate the minimum fluid temperature supplied to your application. For example, if the setpoint is 10°C and the deviation is set to 3°C, the coldest fluid temperature supplied to your application will be limited to 7°C.

The deviation can be set from 1°C to 33°C for standard units, 1°C to 53°C for low-temperature range units. The factory default settings are 30°C and 50°C respectively.

The loop can also be used to set the controller's PID parameters ($COOL HEAT$). The factory preset values are on page 27.



Thermo Fisher recommends that only a qualified technician change PID parameters. Incorrect PID values will hamper unit performance. ▲

The heat PID is only applicable to units configured with a heater.

The loop is also used to adjust/verify serial communication parameters (SER). This section of the loop is applicable only to units configured for serial communications capability.

Changes made in the Tuning/Setup Loop take effect when \blacktriangle is pressed at the $STOP$ prompt. Pressing \blacktriangledown at the prompt aborts *all* changes.

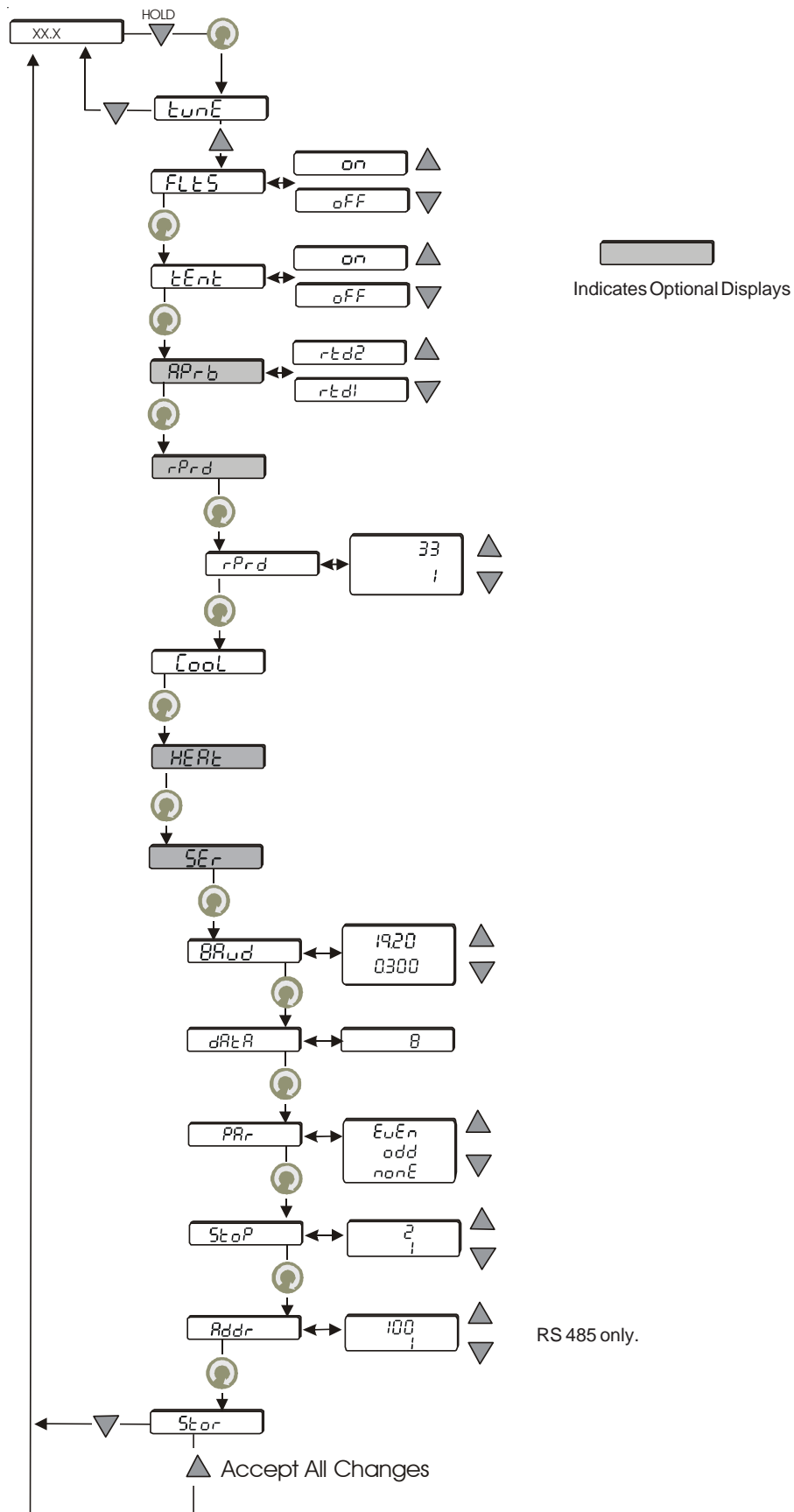



Chapter 3 Options

This chapter contains information about available options.

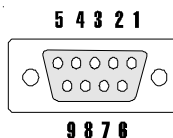

Communication Connector



A female 9-pin D-connector is located on the rear of the unit. The connector is used for either RS-232 or RS-485 serial communication (see Appendix B).

When the unit is configured for serial communication the  LED on the controller is illuminated. If the unit is shut off while still configured for serial communication, the temperature display will go blank, but the  LED will still be illuminated.

When the unit is configured for serial communication the unit can be stopped using the local controller. To restart, send another start command.

NOTE If you need to start the unit using the local controller, simultaneously depress and hold both arrow keys for approximately 10 seconds. The display will show the temperature, and the alarm will sound. Use  and scroll to the  LED and turn it OFF. The unit can now be started and operated from the keypad. ▲

The pin out information is:

Pin	RS-232 COMM	RS-485 COMM
1	No connection	No connection
2	TX	No connection
3	RX	No connection
4	No connection	No connection
5	GND = Signal ground	No connection
6	No connection	No connection
7	No connection	No connection
8	No connection	T+
9	No connection	T-

TX = Transmitted data from controller

RX = Received data to controller.

Hardware Mating Connector AMP Part# 745492-2 or equivalent

Remote Start/Stop

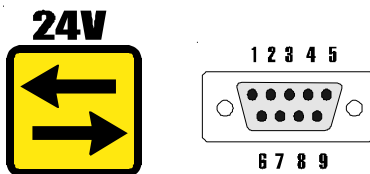

A male 9-pin D-connector is located on the rear of the unit. The connector is used for either 12 - 24VAC or 12 - 24VDC remote start/stop; and as a status relay dry contact.

To start the unit from a remote location apply the correct voltage to pins 6 & 8. When the unit is started by a remote start/stop voltage  on the controller will flash.

Once started remotely, stop the unit by removing the applied voltage from pins 6 & 8 or by pressing  on the local controller. To restart remotely after stopping locally, remove and reapply the remote start voltage to J101.

NOTE Enabling serial communications disables the remote start/stop feature. ▲

Should the unit experience a high/low temperature warning/fault, a reservoir level warning/fault, or a low pump flow warning/fault, the status relay will de-energize.

The pin out information is:

Pin #	Function	Pin #	Function
1	No Connection	6	Remote On +
2	Status, NO	7	RTD2B
3	Status, NC	8	Remote On -
4	RTD2A	9	No Connection
5	Status, Common		

Hardware Mating Connector AMP Part# 745491-2 or equivalent

Remote Start Input

12 to 24 Volts DC $\pm 10\%$ maximum input current, 9ma.

12 to 24 Volts AC $\pm 10\%$ maximum input current, 5ma.

Absolute Maximum Input Voltages



40 volts rms. continuous.

56 volts peak.

Rating for both normally open and normally closed status relay contacts are: Maximum rated load - 1.0 Amp, 24 Volts AC/DC, resistive. Minimum permissible load - 1 ma @ 5 VDC.

External Temperature Sensor



Connect the external sensor to the male 9-pin D-connector located on the rear of the unit, see previous page.

The external temperature sensor is enabled using the controller. With the controller displaying the temperature press  five times. The display will alternate with *rPrb* and either *on* or *off*. If desired, use the arrow keys to change the status and then press  to return to the temperature display.

If the external sensor is selected the controller will display the temperature at the external sensor. Also, the controller indicates the external sensor is selected by flashing the left-most temperature decimal point.

Flashes to indicate the external sensor is enabled.



NOTE To display the internal temperature press and hold  for one second. The display will indicate *rtdi* for ½ second and then display the internal temperature for five seconds. The display then indicates *rtd2* for ½ second and returns to the external temperature. The  key will need to be released and then pressed and held again to repeat the cycle. To display the remote probe temperature deviation use the Setup/Tuning Loop, see page 18. 

The controller continues to use the existing setpoint. When using the external sensor the controller will not allow internal unit temperatures outside 3°C to 37°C for standard temperature range units, -17°C to 37°C for low-temperature range units.

The selected sensor is retained by the controller if it is turned off, or if power is removed.

If there is an external sensor error the unit will automatically return to the internal sensor. An error code will flash and if the fault mode is on the unit will shut down. See Error Codes on page 25. Press  to restart the unit.

The external probe can be used to control the high and low temperature monitors using the Setup/Tuning Loop, see page 18.

NOTE If you also need to monitor status while using the external sensor, an optional Y-connector cable is available from Thermo Fisher. 

Reservoir Level Warning/Fault

Should the reservoir fluid level drop below normal the mutable alarm will sound, the status relay will de-energize (if the unit is equipped with the communications package), an error message will be displayed and, depending on the unit's configuration, the unit will continue to run or shut down. The unit is configured to run or shut down using the controller's Setup/Tuning Loop on page 18.

Refill the reservoir and, if necessary, restart the unit.

NOTE The unit will not start without any fluid in the reservoir regardless of how it is configured. ▲

Low Pump Flow Warning/Fault

Should the pump flow drop below 0.5 gpm (1.0 gpm for units with a CP-55 pump) the mutable alarm will sound, the status relay will de-energize (if the unit is equipped with the communications package), an error message will be displayed, and, depending on the unit's configuration, the unit will continue to run or shut down.

Once the cause of the low flow is identified and corrected restart the unit, if necessary.

The unit is configured to run or shut down using the controller's Setup/Tuning Loop, see page 18.

Additional Accessories

External Filtration Package

A partial flow liquid filter available in 5, 10, 25, and 40 micron filter sizes.

External DEI Package

Partial flow DEI package will maintain between 1 and 3 M Ω cm water resistivity. A cartridge indicator lets you know when the filter needs changing.

Condenser Air Filter

An easy to install air filter protects the condenser in dusty environments.

External Strainer Accessory Kit

An easy to install kit to make routine strainer preventative maintenance easier.

Chapter 4 Maintenance

This chapter covers the unit's basic maintenance.

Error Codes

Er 00 ROM checksum. Clear with  key.

Er 01 Test failure. Locks up the program.

Er 02 Display board failure. Clears when display board is fixed.

Er 03 Critical checksum failure. Clear with  key.

Er 14 Synchronous comm - check connections

Er 15 Asynchronous comm

Er 1b Bad calibration data - redo calibration

Unusual Hardware Conditions

These errors will flash on the display and cannot be cleared. These are internal controller problems.

Er 04 through *Er 13* - Interrupt errors during runtime.

Er 0f BOM invalid

Functional/ Machine errors

These errors will clear themselves once the problem disappears.

Display Indication

Lo t Low temp setpoint warning/fault

Fl d Low level warning, fluid below minimum fill level, see page 12

Hi t High temp setpoint warning/fault

Er 23 Shorted external temperature sensor (rdt2)



Er 24 Open external temperature sensor (rdt2)

- E_r 25** Shorted internal temperature sensor (rtd1)
- E_r 2b** Open internal temperature sensor (rtd1)
- E_r 33** Reservoir fluid below 1°C, standard-temp units only
- L_oFL** Low process flow warning/fault
- LLF** Fluid low level fault - unit shuts down

Unit reaction to warning/fault errors depend on how the unit is configured, see Setup/Tuning Loop on page 18. The unit is shipped configured to continue running. If any other code appears contact our customer service.

Displaying Software Version Number

The controller can display the installed software version number. For example, for a unit with software version **026950.1A**:

1. Unit is running normally and displaying recirculating fluid temperature.
2. Press and hold  for at least 10 seconds. The display will show the first two digits, for example: **02**.
3. Press 

The display will show the remaining digits to the left of the decimal, for example: **6950**.
4. Press 

The display will show the decimal point and the digit to the right of the decimal point, for example, **.1**.
5. Press 

The display will show the revision letter, as its equivalent number, for example, **1 = A**.
6. Press 

Disregard this display.
7. Press 

The display returns to the recirculating fluid temperature.

Controller PID Values

The factory preset PID values are:

	P	I	D
COOL			
STD TEMP UNITS	20	0.5	0.0
LOW TEMP UNITS	12	0.5	0.0
HEAT			
ALL UNITS	5	0.5	0.0



Cleaning

Thermo Fisher recommends that only a qualified technician change PID parameters. Incorrect PID values will hamper unit performance. ▲

Reservoir

Periodically inspect the fluid inside the reservoir. If cleaning is necessary, flush the reservoir with a cleaning fluid compatible with the circulating system and the cooling fluid.

The cooling fluid should be replaced periodically. Replacement frequency depends on the operating environment and amount of usage.



Before changing the cooling fluid ensure it is at a safe handling temperature. ▲

NOTE It will be necessary to use a wet-vac or siphon to completely drain the reservoir. Use care so as not to damage the reservoir float switch. ▲

See page 12, Filling Requirements, for instructions on cooling fluid replacement.

Condenser

For proper operation, the unit needs to pull substantial amounts of air through a condenser. A build up of dust or debris on the fins of the condenser will lead to a loss of cooling capacity. Optional air filters are available, contact our Service Department. See Preface, After-Sale Support.

The lower front of the unit has a one-piece grille assembly. Using your hands gently pry the assembly off. Use care not to scratch the paint.

Periodic vacuuming of the condenser fins is necessary. The cleaning frequency depends on the operating environment. After initial

installation we recommend a monthly visual inspection of the condenser. After several months, the cleaning frequency will be established.



Use care cleaning the condenser fins, they can be easily bent. ▲

Algae

To restrict the growth of algae in the reservoir, we recommend keeping the reservoir cover in place and using opaque circulation lines. This will eliminate the entrance of light required for the growth of most common algae.

We recommend the use of Chloramine-T, 1 gram per 3.5 liters. Other algaecides can be harmful to the unit's internal components. Contact Thermo Fisher for additional information.

Leaks

A very small leak between the pump and motor is normal. If this is a new pump, allow it to run for 24 hours and reinspect. A continuous leak will require pump replacement.

Phase Rotation Interlock

Three phase units have a rotation interlock which prevents the unit from starting if the phase rotation is wrong. If the unit will not start, see Section VII, Troubleshooting. If the options in the checklist are not applicable, the problem may be phase rotation.

The interlock is located in the power box. Remove the unit's top and left-side panel to access it. The interlock has a green light which illuminates when the phase is correct.

If the phase is incorrect, disconnect the unit from its power source. Reverse any two line conductors on the line side of the main circuit breaker.



Never remove the green ground wire. ▲

Reconnect the unit to its power source. If the unit will not start, contact our Service Department.

PD Pressure Relief Valve



Units with PD pumps have a Pressure Relief Valve. Refer to the name plate label on the rear of the unit and the BOM decoder on page 32 to identify the type of pump. The valve is used to adjust the unit's fluid pressure.

NOTE The valve is factory preset for the most common applications and normally requires no further adjustment. The valve is factory preset not to exceed 80 ± 5 psi (550 ± 1 kPa). ▲

NOTE PD pumps are capable of 110 psi maximum output pressure. Ensure your plumbing is rated to withstand 110 psi at the highest operating temperatures. ▲

System back pressure is installation and application dependent. Due to internal Merlin back pressure, the minimum pressure setting for a deadheaded pump is 28 psi for a PD-2 pump, and 10 psi for a PD-1 (these settings prohibit external flow from the Merlin).

Before adjusting the valve turn the unit off. Locate the circular relief valve opening on the rear of the unit. Turn the threaded stem fully clockwise.

If the unit is not plumbed to an application, install a loop of hose equipped with a shut-off valve between the supply and return fittings.

Turn the unit on. Ensure that there is back pressure on the system. Use the pressure gauge to read the relief valve setting.

Back out the threaded stem on the relief valve counterclockwise. Continue until the gauge indicates 80 psi (550 kPa) or the desired setting.

NOTE The relief valve may drip if the threaded stem is backed out too far. ▲

NOTE Should the unit start to vibrate the valve setting may be the cause. Changing the pressure setting ± 5 psi will eliminate the vibration. ▲

Pump Strainer

Units with PD pumps, and units with CP-55 pumps that are equipped with reservoir level/low pump flow switches, have a strainer. Refer to the name plate label on the rear of the unit and the BOM decoder on page 32 to identify the type of pump and configuration.

If debris is in the system, the strainer will prevent the material from being drawn into the flow switch and the pump, damaging the pump vanes. A clogged strainer will also cause increased discharge pump pressures.

After initial installation, the strainer may become clogged with debris and scale. Therefore, **the strainer must be cleaned after the first week of installation.** After this first cleaning, we recommend a monthly visual inspection. After several months, the cleaning frequency will be established.



Before cleaning the strainer ensure the cooling fluid is at a safe handling temperature. Disconnect the power cord from the power source. ▲

We also recommend draining the reservoir.

The strainer is in the pump return line, the exact location depends on the unit's configuration. For most configurations it is located behind the rear panel. For units configured with low level and low temperature switches, it is behind the right-side panel.

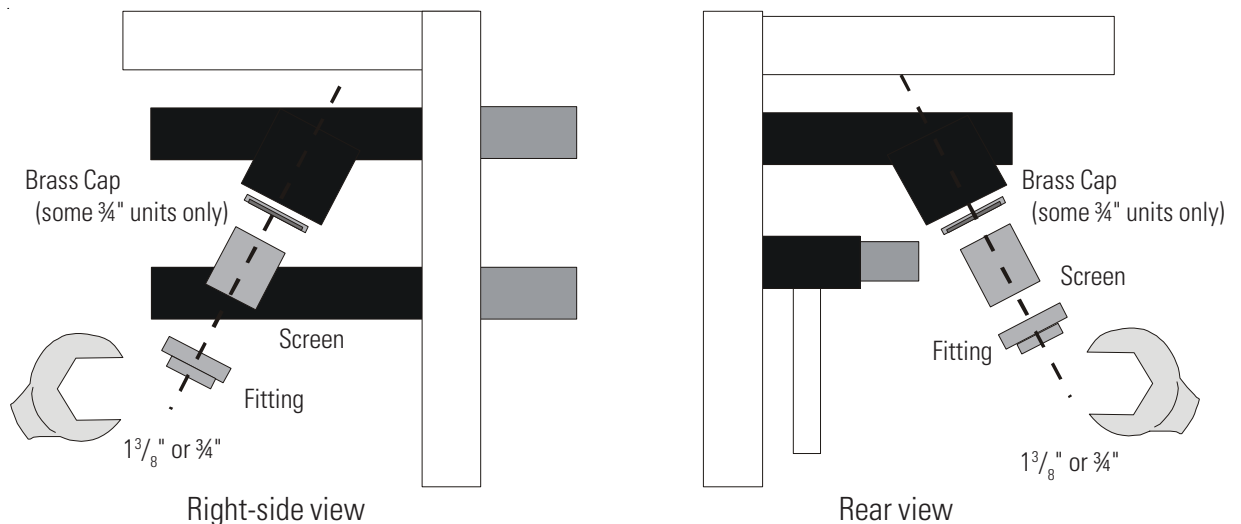

NOTE A small amount of fluid will come out of the internal strainer housing when the fitting is removed. Have a rag handy to put under the housing before removing the fitting. ▲

Remove the panel from the unit. Use one wrench to support the filter housing, and a second wrench to unscrew the fitting, 1³/₈ inch for CP pumps, or 3/4 inch for PD pumps. Remove the screen.

NOTE Some units with 3/4 inch fittings also have a brass end cap, see illustration below. ▲

Clean the screen by rinsing it with water. When the screen is clean, replace it and the cap. Tighten the fitting and replace the panel. Refer to Section III for instructions on replacing the cooling fluid.

NOTE An external strainer accessory kit is available to make routine strainer preventative maintenance easier. The part number is 62700000010. ▲

PD Pump Motor Lubrication

Some PD pumps use sleeve type bearings with large reservoirs. Oiling instructions are generally posted on each motor. In the absence of instructions, add approximately 30 to 35 drops of SAE 20 (142 CS viscosity) non-detergent oil (i.e. 3-IN-ONE® Tool Oil) to each bearing on the following schedule:

Duty Cycle	Oiling Frequency
Continuous	Once every year
Intermittent	Once every 2 years
Occasional	Once every 5 years

Fill Holes (Typical)

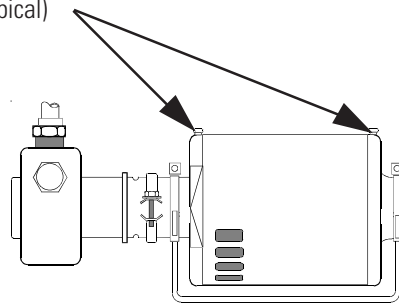

Storage



If the unit is to be transported and/or stored in cold temperatures it needs to be drained and then flushed with a 50/50 glycol/water mixture. ▲

BOM Decoder

The Bill of Material (BOM) number helps identify the configuration of your unit. The number is printed on the label located on the rear of the unit.

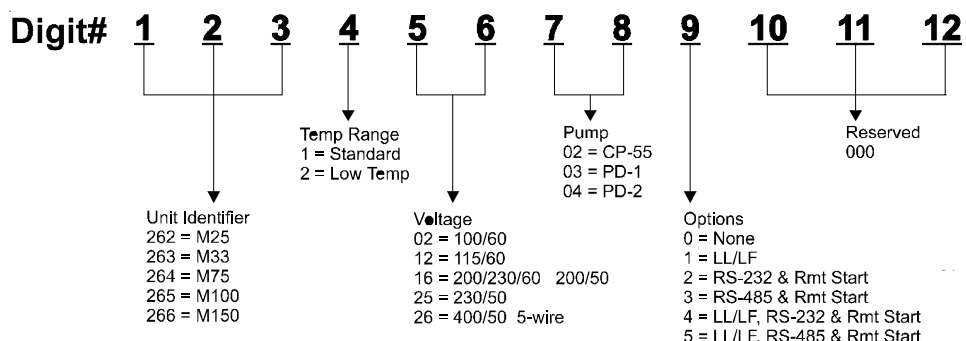

Temperature Sensor Calibration

Internal Sensor

If the temperature fluid temperature display disagrees with your reference thermometer, the internal temperature sensor (rtd1) may need calibration.

Do not pick calibration points that are outside the safe operating limits of the fluid in your application. For example with water, 35°C and 5°C would be typical calibration points.

Run the unit to a high-end calibration point. Place a calibrated reference thermometer in the reservoir, ensure the fluid temperature is stable.

Enter Calibration by pressing and holding ▼ and then pressing ▲ three times. The display will read CAL. Press ▲ and the display will read rtd1.

To calibrate the high-end temperature press ▲ and the display will read r1H. Press ▲ again and the display will flash between r1H and the current probe temperature.

Use ▲ and ▼ to adjust the r1H display. Once the display temperature matches the reference thermometer press ⏸ twice. Press ⏸ until Stor is displayed, press ▲ to accept the new value.

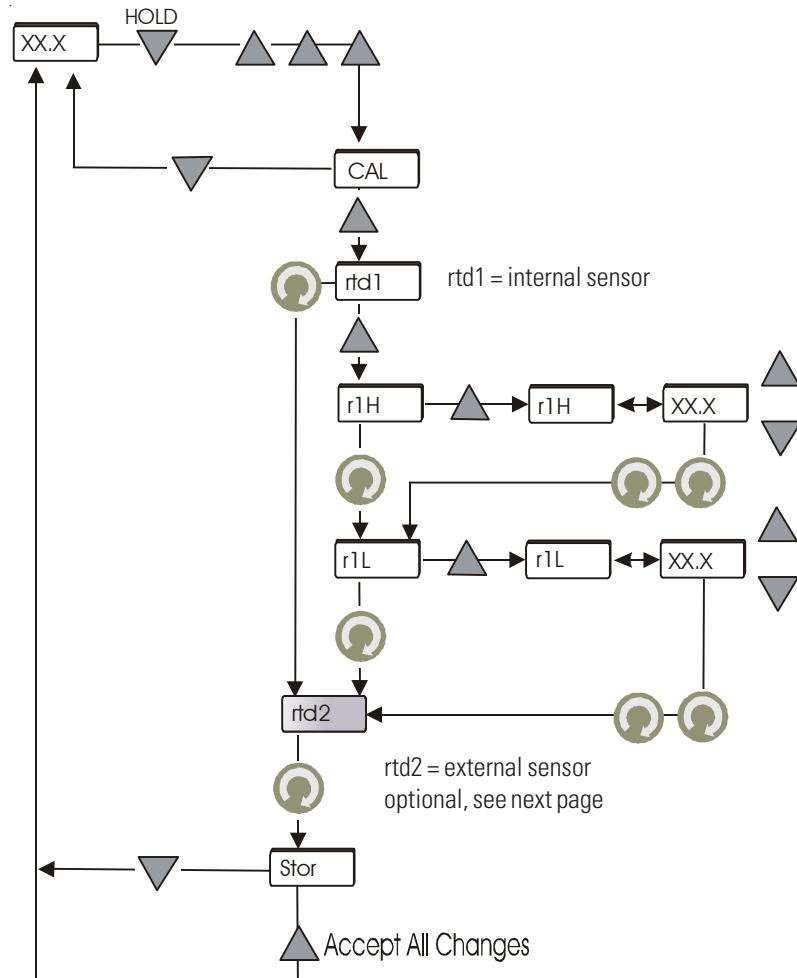

Repeat for the low-end temperature r1L.

NOTE Both the high and low temperatures must be entered for a valid calibration. If power is lost before the procedure is complete, critical data needed for the calculation of calibration parameters will be lost. After pressing ▲ at the Stor prompt wait several seconds before proceeding to ensure that a bad calibration message does not appear. Premature use of the keypad after pressing ▲ may cancel the bad calibration error message. ▲

External Sensor

When using any external sensor (rtd2) for the first time, Thermo Fisher recommends a two-point calibration. This calibration will only affect the temperature read by the external sensor.



Do not pick calibration points that are outside the safe operating limits of the fluid in your application. For example with water, 35°C and 5°C would be typical calibration points.

Enter the Calibration Loop by pressing and holding ▼ and then pressing the ▲ three times. The display will read CAL. Press ▲ and the display will read rtd1, then press 🕒 and the display will read rtd2.

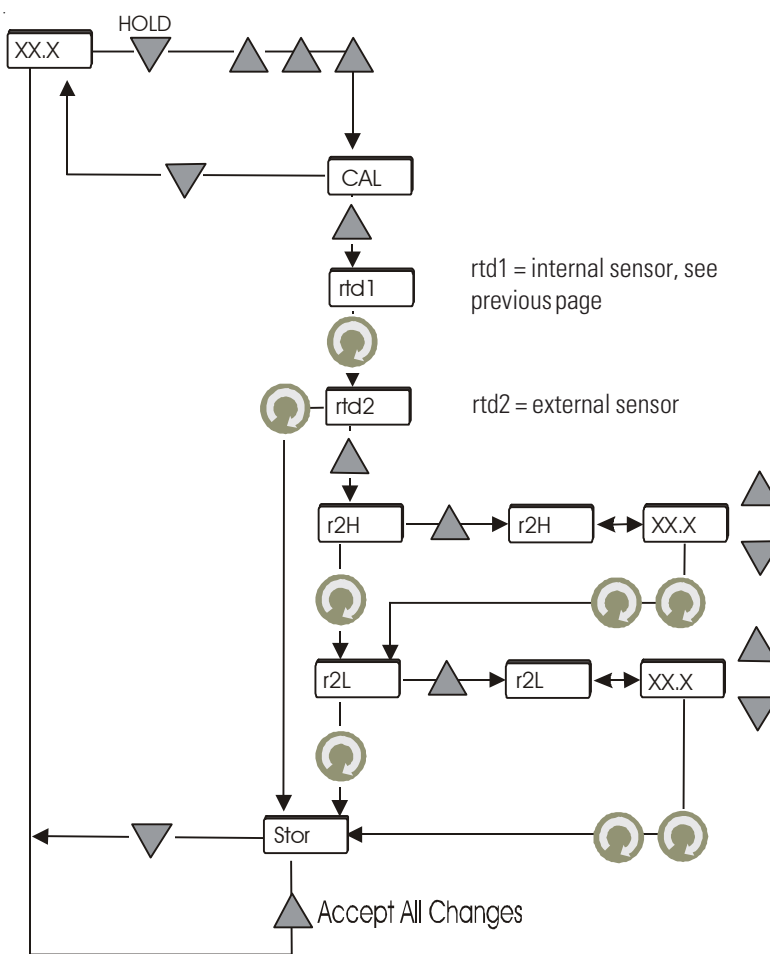
To calibrate the high-end temperature press ▲ and the display will read r2H. Press ▲ again and the display will flash between r2H and the current probe temperature.



Place the external sensor and a calibrated reference thermometer in a source containing fluid that is just below the high-end temperature range of the unit, ensure the fluid temperature is stable. Use ▲ and ▼ to adjust the temperature display to match the reference thermometer.

Once the display temperature matches the reference thermometer press  twice. Press  until Stor is displayed, pressing ▲ accepts the new value.

Repeat for the low-end temperature, r2L. Use a fluid that is just above the low-end temperature range of the unit.

NOTE Both the high and low temperatures must be entered for a valid calibration. If power is lost before the procedure is complete, critical data needed for the calculation of calibration parameters will be lost. After pressing ▲ at the Stor prompt wait several seconds before proceeding to ensure that a bad calibration message does not appear. Premature use of the keypad after pressing ▲ may cancel the bad calibration error message. ▲

Chapter 5 Troubleshooting



This chapter covers the basic troubleshooting procedures.

Checklist

1. Unit will not start or shuts down

- a. Check the line cord; ensure it is plugged in.
- b. Check the position of the circuit protector on the rear of the unit.
- c. Check the controller for error codes, see page 25.

NOTE On units with a Low Flow Switch, and that are configured to shut down with a low flow fault (*LFL*), several starting attempts may be necessary. ▲

- d. On units with a Reservoir Level Switch, check the reservoir level.
- e. On units with optional serial communications or remote start/stop, ensure the desired mode is enabled.
- f. Make sure power source voltage is within the unit rated voltage $\pm 10\%$.
- g. 400 Volt, 50 Hertz units are equipped with a phase monitor. Ensure proper phase to the unit. See Phase Rotation Interlock on page 28.
- h. If  is lit, the unit was shut off using serial communications. Start the unit using serial communications. To start the unit using the local controller press and hold both arrow keys for 10 seconds, the controller will power. Turn serial communications off using the procedure on page 16, and then press  to turn off the controller. Press  again to start the unit.

2. Unit will not circulate fluid

- a. Check the reservoir level. Fill, if necessary.
- b. Check the position of the reservoir tank valves. See Reservoir Tank Isolation Valves/Open Tank Circulation, Chapter 2.
- c. Check the instrument being cooled for restrictions in the cooling line.
- d. Check the pump strainer (units with PD pumps).
- e. The pump motor may be too hot. Allow it to cool.
- f. Check the pressure gauge, adjust the relief valve as necessary (units with PD pumps).
- g. On units with PD pumps, check the pump and coupling. Make sure the power is off and remove the top and right-side panels. Locate the brass pump and grey motor. A silver clamp ring holds the two together. Remove the clamp and separate the pump and motor. First look to see if the coupling is broken or not, and then check the pump shaft by rotating. If it is seized or sticks then it has failed.

3. Inadequate temperature control

- a. Verify the setpoint.
- b. If the temperature continues to rise, make sure your application's heat load does not exceed the rated specification, see Chapter 2, Specifications.
- c. Make sure the air intake and discharge are not impeded and the ambient temperature does not exceed +35°C.
- d. Make sure the condenser is free of dust and debris, see Chapter 4, Maintenance and Cleaning.
- e. Verify the controller's PID values, see Setup/Tuning Loop.

4. Unit runs loudly

- a. Check the position of the reservoir tank valves. See Reservoir Tank Isolation Valves/Open Tank Circulation, Chapter 2.

5. Condensation on reservoir

- a. Check the position of the upper reservoir tank valve. See Reservoir Tank Isolation Valves/Open Tank Circulation, Chapter 2.

6. Unit vibrates

- a. The external pressure relief valve may need adjustment. Change the pressure setting ± 5 psi, see Chapter 4.

7. No serial communications (optional)

- a. All units are tested for serial communications before they leave the factory. Check the controller, ensure serial communication is enabled.
- b. Check all communications commands, they *must be exact*. See Appendix B.
- c. Check all wiring for proper connections or possible shorts.
- d. Software to verify serial communication is available from Thermo Fisher.

Service Assistance

If, after following these troubleshooting steps, your unit fails to operate properly, contact our Service Department for assistance (see Preface, After-sale Support). Before calling, *please* obtain the following information:

Before calling, *please* obtain the following information:

- unit BOM number
- unit serial number
- unit software version (page 26)
- voltage of power source

Appendix A Water Quality and Standards

Contaminants

	Permissible (PPM)	Desirable (PPM)
Microbiologicals		
(algae, bacteria, fungi)	0	0
Inorganic Chemicals		
Calcium	<40	<0.6
Chloride	<250	<25
Copper	<1.3	<1.0
Iron	<0.3	<0.1
Lead	<0.015	0
Magnesium	<12	<0.1
Manganese	<0.05	<0.03
Nitrates\Nitrites	<10 as N	0
Potassium	<20	<0.3
Silicate	<25	<1.0
Sodium	<20	<0.3
Sulfate	<250	<50
Hardness	<17	<0.05
Total Dissolved Solids	<50	<10
Other Parameters		
pH	6.5-8.5	7-8
Resistivity	0.01*	0.05-0.1*

* MΩ cm (Compensated to 25°C)

Unfavorably high total ionized solids (TIS) can accelerate the rate of galvanic corrosion. These contaminants can function as electrolytes which increase the potential for galvanic cell corrosion and lead to localized corrosion such as pitting which can be observed at the studs and on the outside surface of cooling coils. Eventually, the pitting will become so extensive that the coil will leak refrigerant into the water reservoir.

For example, raw water in the U.S. averages 171 ppm (of NaCl). The recommended level for use in a water system is between 0.5 to 5.0 ppm (of NaCl).

Recommendation: Initially fill the tank with distilled/deionized water. Do not use untreated tap water as the total ionized solids level may be too high.

The desired level for long time usage is 1 to 3 MΩ cm (compensated to 25°C). This will reduce the electrolytic potential of the water and prevent or reduce the galvanic corrosion observed.

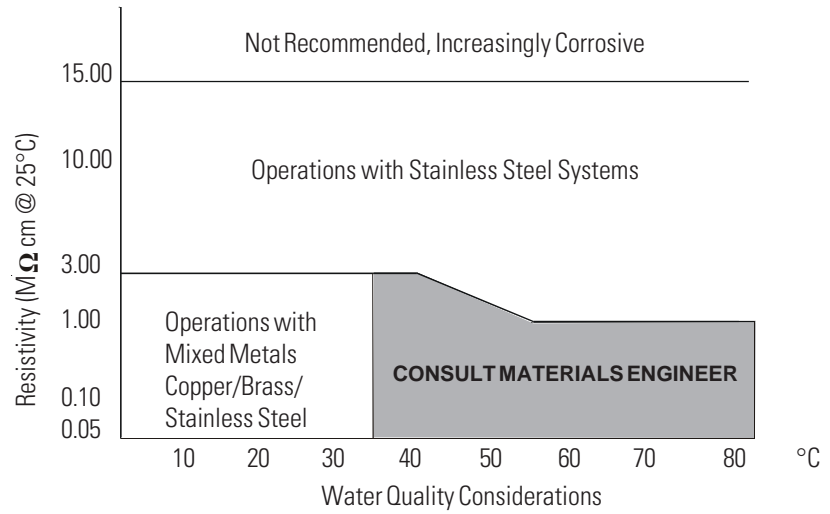

Compatibility with Recommended Fluids



Never use flammable or corrosive fluids with this unit. Do not use automotive antifreeze. Commercial antifreeze contains silicates that can damage the pump seals. Use of automotive antifreeze will void the manufacturer's warranty. ▲

Filtered/Single Distilled water, +5°C to +35°C

This fluid is recommended primarily because it has all microorganisms that cause biological fouling removed through vaporizing and condensing the water. However, distilled water does not remain pure for very long when exposed to the atmosphere. Air-borne spores can contaminate the water and activate algae growth. An effective maintenance plan would include switching out the fluid with newly distilled water every six months. The particulates that have been filtered out in the process are also preventative in keeping the system “clean” of contaminants.

50/50 Uninhibited Ethylene Glycol/Water (-15°C to + 35°C)

Ethylene glycol is used to depress the freezing point of water as a coolant. We recommend not using the uninhibited (no corrosion additives) ethylene glycol. It is more corrosive to copper than plain water so it is not recommended unless required for the application.

50/50 Inhibited Ethylene Glycol/ Water (-15°C to +35°C)

Inhibited glycol can be used to increase the operating temperature range of the fluid but should not be used as a “pre-mixed anticorrosive” solution. Industry standards use a pH standard of 8 to determine when the fluid has become corrosive. Dowtherm[®] is an ethylene based product that contains dipotassium phosphates in a 4% concentration. The recommended use of Dowtherm[®] is mixing with distilled or deionized water or water that contains less than 25 ppm chloride and sulfate and less than 100 ppm total hardness of CaCO₃.

The general term, inhibited glycol/water, is too close to meaning inhibited water. Inhibited water can have many types of additives including chromate that will quickly foul the cooling system. Some inhibitor additives can release the bonding agent in the carbon graphite in the PD2 pumps so they are incompatible, such as Sodium Hydroxide.

50/50 Uninhibited Propylene Water (-15°C to +35°C)

Although the use of propylene glycol is similar to ethylene glycol, propylene glycol is considered “safe” to use in the food industry. Propylene is less dense than ethylene and will have a tendency to weep through mechanical seals.

50/50 Inhibited Propylene/ Water (-15°C to +35°C)

Same issues as with uninhibited propylene and inhibited ethylene glycol.

Deionized water (1-3 MΩ cm, compensated, +5°C to +35°C)

Deionized water has had the conductive ions that cause galvanic corrosion between dissimilar metals removed.

Wetted Materials

PD PUMPS (PD1 and PD2):

Carbon Graphite (Graphitar Type B)
Brass
303 Stainless Steel
Ceramic (85% Aluminum Oxide and Balance is Considered Glass)
Fluorocarbon (Viton equivalent)
Ultem (relief Valve Material)

CP-55 PUMP:

Stainless Steel
Viton

Evaporator

AISI 316 Stainless Steel
Copper Brazing

Tank Body

Polyethylene (LLPDE, Mobile NRP=135)

Hose Assemblies/Plumbing:

Buna-N (Parker Push-Lok O-ring)
Nitrile based synthetic rubber (Parker Push-Lok hoses)
Brass
Copper

Ball Valve:

Viton
Chrome plated brass body and ball
PTFE

Sealants:

95/5 solder
Bcup 5 brazing
Anaerobic Mythacrylate Ester

Low Level/Low Flow Switches (Optional):

Polysulphone Low Level
Brass Low Flow

Tank Fittings:

Brass

Strainer

Bronze
304 Stainless Steel Mesh

Tank Cap:

Nylon

Appendix B NC Serial Communications Protocol

NOTE This appendix assumes you have a basic understanding of communications protocols. ▲

All data is sent and received in binary form, do not use ASCII. In the following pages the binary data is represented in hexadecimal (hex) format.

The NC Serial Communications Protocol is based on a master-slave model. The master is a host computer, while the slave is the chiller's controller. Only the master can initiate a communications transaction (half-duplex). The slave ends the transaction by responding to the master's query. The protocol uses an RS-232/RS-485 serial interface with the default parameters: 9600 baud, 8 data bits, 1 stop bit, no parity and no RS-232 handshaking. RS-485 offers a slave address selection from 1 to 100, default parameter: 1.

NOTE Before the unit will communicate, ensure the  indicator is illuminated. ▲

The unit can be controlled through your computer's serial port by using the unit's standard 9-pin connection, see Chapter 3 for pin out information.

Communication cables are available from Thermo Fisher. Contact our sales department for additional information.

All commands must be entered in the exact format shown in the tables on the following pages. The tables show all commands available, their format and responses. Controller responses are either the requested data or an error message. The controller response *must* be received before the host sends the next command.

The host sends a command embedded in a single communications packet, then waits for the controller's response. If the command is not understood or the checksums do not agree, the controller responds with an error command. Otherwise, the controller responds with the requested data. If the controller fails to respond within 1 second, the host should resend the command.

NOTE All byte values are shown in hex, hex represents the binary values that must be sent to the chiller. **Do not use ASCII.** ▲

The framing of the communications packet in both directions is:

Checksum region								
Lead char CA or CC	Addr-MSB 0	Addr-LSB 1	Command	n d-bytes	d-byte 1	...	d-byte n	Checksum
<i>Lead char</i>	0xCA (RS-232) 0xCC (RS-485)							
<i>Addr-msb</i>	Device address is 1 (RS-232)							
<i>Addr-lsb</i>	Most significant byte of device address (RS-232: 0).							
<i>Command</i>	Least significant byte of device address is 1 (RS-232).							
<i>n d-bytes</i>	Command byte (see Table 1).							
<i>d-byte 1</i>	Number of data bytes to follow (00 to 03 hex).							
...	1 st data byte (the qualifier byte is considered a data byte).							
<i>d-byte n</i>	...							
<i>Checksum</i>	n th data byte.							
	Bitwise inversion of the 1 byte sum of bytes beginning with the most significant address byte and ending with the byte preceding the checksum. (To perform a bitwise inversion, "exclusive OR" the one byte sum with FF hex.)							

The master requests information by sending one of the Read Functions as shown in Table 1. Since no data is sent to the chiller during a read request, the master uses 00 for the number of data bytes following the command byte.

The chiller will respond to a Read Function by echoing the lead character, address, and command byte, followed by the requested data and checksum. When the chiller sends data, a qualifier byte is sent first, followed by a two byte signed integer (16 bit, MSB sent first). The qualifier byte indicates the precision and units of measure for the requested data as detailed in Table 2.

As an RS-232 example, the master requests to read internal temperature unit address 01 by sending:



If the temperature is -12°C, the unit would reply:

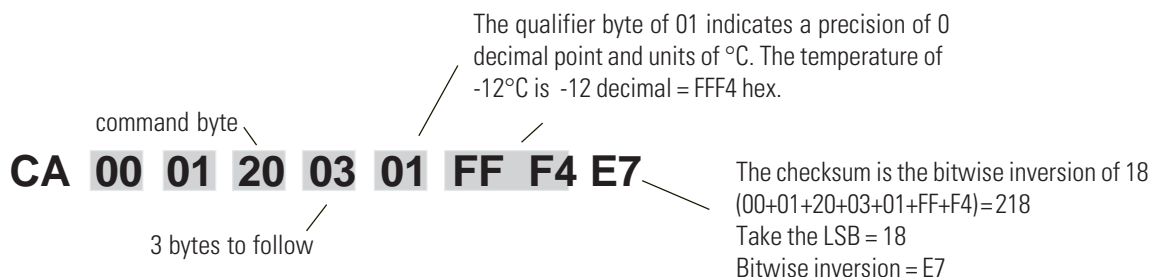

The master sets parameters in the chiller by sending one of the Set Functions as shown in Table 1. The master does not send a qualifier byte in the data field. The master should be preprogrammed to send the correct precision and units (it could also read the parameter of interest first to decode the correct precision and units needed).

For example, if the master wants to set the setpoint to 30°C, it would send :

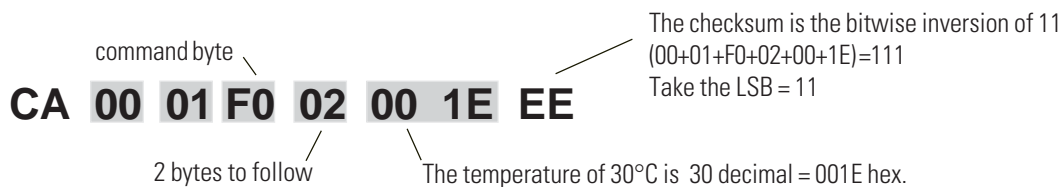

The unit responds:

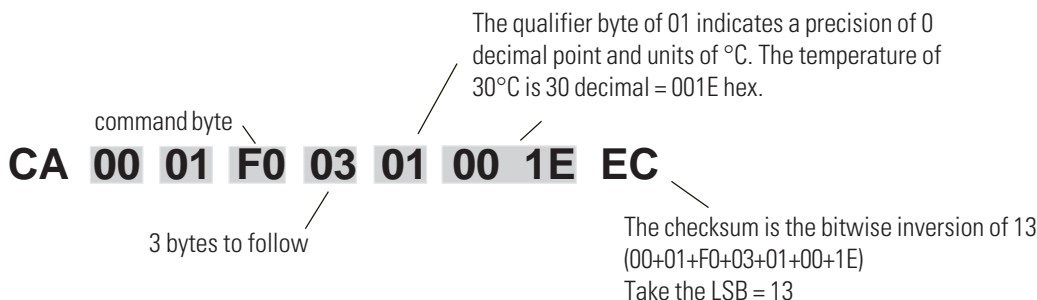

Table 1 Commands (All bytes are in hex)

FUNCTION	MASTER SENDS	UNIT RESPONDS
Read Acknowledge	CA 00 01 00 00 FE	CA 00 01 00 02(v1)(v2)(cs)
Read Status (see Table 3)	CA 00 01 09 00 F5	CA 00 01 09 02(d1)(d2)(cs)
Error		CA 00 01 0F 02(en)(ed)(cs)
Read Internal Temperature (RTD1)	CA 00 01 20 00 DE	CA 00 01 20 03(qb)(d1)(d2)(cs)
Read External Temperature(RTD2)	CA 00 01 21 00 DD	CA 00 01 21 03(qb)(d1)(d2)(cs)
Read Setpoint (control point)	CA 00 01 70 00 8E	CA 00 01 70 03(qb)(d1)(d2)(cs)
Read Low Temperature Limit	CA 00 01 40 00 BE	CA 00 01 40 03(qb)(d1)(d2)(cs)
Read High Temperature Limit	CA 00 01 60 00 9E	CA 00 01 60 03(qb)(d1)(d2)(cs)
Read Cool Proportional Band (P)	CA 00 01 74 00 8A	CA 00 01 74 03(qb)(d1)(d2)(cs)
Read Cool Integral (I)	CA 00 01 75 00 89	CA 00 01 75 03(qb)(d1)(d2)(cs)
Read Cool Derivative (D)	CA 00 01 76 00 88	CA 00 01 76 03(qb)(d1)(d2)(cs)
Read Heat Proportional Band (P)	CA 00 01 71 00 8D	CA 00 01 71 03(qb)(d1)(d2)(cs)
Read Heat Integral (I)	CA 00 01 72 00 8C	CA 00 01 72 03(qb)(d1)(d2)(cs)
Read Heat Derivative (D)	CA 00 01 73 00 8B	CA 00 01 73 03(qb)(d1)(d2)(cs)

command bytes shown in **bold**
 qb = qualifier byte, see Table 2
 d1,d2 = 16 bit signed integer of the value being sent or received
 cs = the checksum of the string (see text)

v1. v2 = protocol version
 ed Bad command byte gets echoed
 en (error number) 01 = Bad command,
 02 = Bad checksum
 xx = no valid data, include in checksum

Table 1 Commands (continued) (All bytes are in hex)

FUNCTION	MASTER SENDS	UNIT RESPONDS
Set Setpoint (control point)*	CA 00 01 F0 02(d1)(d2)(cs)	CA 00 01 F0 03(qb)(d1)(d2)(cs)
Set Low Temp	CA 00 01 C0 02(d1)(d2)(cs)	CA 00 01 C0 03(qb)(d1)(d2)(cs)
Set High Temp	CA 00 01 E0 02(d1)(d2)(cs)	CA 00 01 E0 03(qb)(d1)(d2)(cs)
Set Cool Proportional Band (P = 0.1 - 99.9)	CA 00 01 F4 02(d1)(d2)(cs)	CA 00 01 F4 03(qb)(d1)(d2)(cs)
Set Cool Integral (I = 0 - 9.99)	CA 00 01 F5 02(d1)(d2)(cs)	CA 00 01 F5 03(qb)(d1)(d2)(cs)
Set Cool Derivative (D = 0 - 5.0)	CA 00 01 F6 02(d1)(d2)(cs)	CA 00 01 F6 03(qb)(d1)(d2)(cs)
Set Heat Proportional Band (P = 0.1 - 99.9)	CA 00 01 F1 02(d1)(d2)(cs)	CA 00 01 F1 03(qb)(d1)(d2)(cs)
Set Heat Integral (I = 0 - 9.99)	CA 00 01 F2 02(d1)(d2)(cs)	CA 00 01 F2 03(qb)(d1)(d2)(cs)
Set Heat Derivative (D = 0 - 5.0)	CA 00 01 F3 02(d1)(d2)(cs)	CA 00 01 F3 03(qb)(d1)(d2)(cs)
Set On/Off Array		

The Set On/Off Array command is used to set and/or request unit settings. Depending on the software version, the array consists of up to 5 data bytes, d1 - d5. Each byte represents the state of one setting, see ** below. The master can send the array with a value of 0 (turn off/disable), 1 (turn on/enable), or 2 (do not change). 0 or 1 causes the unit to change the setting, 2 only requests the state of a setting. The slave returns values of 0 (off/disabled) or 1 (on/enabled).

(SW Version 02950.1A-E)	CA 00 01 81 01(d1)(cs)	CA 00 01 81 01(d1)(cs)
(SW Version 02950.1F-H)	CA 00 01 81 04(d1)... (d4)(cs)	CA 00 01 81 04(d1)... (d4)(cs)
(SW Version 02950.1J-K)	CA 00 01 81 05(d1)... (d5)(cs)	CA 00 01 81 05(d1)... (d5)(cs)
(SW Version 02950.1L-)	Any of the above formats	
Sample - turn unit on (02950.1J-K)	CA 00 01 81 05 01 02 02 02 02 6F	

* = limited to the range of the chiller
 command bytes shown in **bold**
 qb = qualifier byte, see Table 2
 d1,d2 = 16 bit signed integer of the value being sent or received
 cs = the checksum of the string (see text)

**d1 - unit off = 0, on =1
 d2 - external sensor disabled = 0, enabled = 1
 d3 - fault mode disabled = 0, enabled = 1
 d4 - tenths display disabled = 0, enabled = 1
 d5 - Alarms on internal = 0, or external sensor = 1, (1 is invalid when d2 = 0, external sensor disabled)

Table 2

QUALIFIER BYTE	
00	0 precision, no units of measure
01	0 precision, °C
10	1 precision, no units of measure
11	1 precision, °C
20	2 precision, no units of measure

Example: The temperature of 45.6°C would be represented by the qualifier 11 hex, followed by the 2 bytes 01 C8 hex (456 decimal).

Table 3 READ STATUS

BIT	d1	d2^t
b.7 = 1	External Temp Sensor Enabled	Reserved
b.6 = 1	Level 1 Warning/Auto Refill	Reserved
b.5 = 1	Low Flow Warning	Internal Temp Sensor Fault
b.4 = 1	Low Level 2 Warning	External Temp Sensor Fault
b.3 = 1	High or Low Temp Warning	High Temp/Fixed High Temp Fault
b.2 = 1	High or Low Temp Bypass	Low Temp/Fixed Low Temp Fault
b.1 = 1	Unit Faulted*	Low Flow Fault
b.0 = 1	Unit Running*	Low Level 2 Fault

t d2 is the detail of fault d1-b.1

* mutually exclusive

WARRANTY

Thermo Fisher Scientific warrants for 24 months from date of shipment the Thermo Scientific NESLAB Merlin unit according to the following terms.

Any part of the unit manufactured or supplied by Thermo Fisher Scientific and found in the reasonable judgment of Thermo Fisher to be defective in material or workmanship will be repaired at an authorized Thermo Fisher Repair Depot without charge for parts or labor. The unit, including any defective part must be returned to an authorized Thermo Fisher Repair Depot within the warranty period. The expense of returning the unit to the authorized Thermo Fisher Repair Depot for warranty service will be paid for by the buyer. Our responsibility in respect to warranty claims is limited to performing the required repairs or replacements, and no claim of breach of warranty shall be cause for cancellation or rescission of the contract of sales of any unit. With respect to units that qualify for field service repairs, Thermo Fisher Scientific's responsibility is limited to the component parts necessary for the repair and the labor that is required on site to perform the repair. Any travel labor or mileage charges are the financial responsibility of the buyer.

The buyer shall be responsible for any evaluation or warranty service call (including labor charges) if no defects are found with the Thermo Scientific product.

This warranty does not cover any unit that has been subject to misuse, neglect, or accident. This warranty does not apply to any damage to the unit that is the result of improper installation or maintenance, or to any unit that has been operated or maintained in any way contrary to the operating or maintenance instructions specified in this Instruction and Operation Manual. This warranty does not cover any unit that has been altered or modified so as to change its intended use.

In addition, this warranty does not extend to repairs made by the use of parts, accessories, or fluids which are either incompatible with the unit or adversely affect its operation, performance, or durability.

Thermo Fisher Scientific reserves the right to change or improve the design of any unit without assuming any obligation to modify any unit previously manufactured.

THE FOREGOING EXPRESS WARRANTY IS IN LIEU OF ALL OTHER WARRANTIES, EXPRESSED OR IMPLIED, INCLUDING BUT NOT LIMITED TO WARRANTIES OR MERCHANTABILITY AND FITNESS FOR A PARTICULAR PURPOSE.

OUR OBLIGATION UNDER THIS WARRANTY IS STRICTLY AND EXCLUSIVELY LIMITED TO THE REPAIR OR REPLACEMENT OF DEFECTIVE COMPONENT PARTS AND Thermo Fisher Scientific DOES NOT ASSUME OR AUTHORIZE ANYONE TO ASSUME FOR IT ANY OTHER OBLIGATION.

Thermo Fisher Scientific ASSUMES NO RESPONSIBILITY FOR INCIDENTAL, CONSEQUENTIAL, OR OTHER DAMAGES INCLUDING, BUT NOT LIMITED TO LOSS OR DAMAGE TO PROPERTY, LOSS OF PROFITS OR REVENUE, LOSS OF THE UNIT, LOSS OF TIME, OR INCONVENIENCE.

This warranty applies to units sold in the United States. Any units sold elsewhere are warranted by the affiliated marketing company of Thermo Fisher Scientific. This warranty and all matters arising pursuant to it shall be governed by the law of the State of New Hampshire, United States. All legal actions brought in relation hereto shall be filed in the appropriate state or federal courts in New Hampshire, unless waived by Thermo Fisher Scientific.